

# Binocular Stereo



**Dr. Elli Angelopoulou**

**Pattern Recognition Lab (Computer Science 5)**

**University of Erlangen-Nuremberg**

# Binocular Stereo Example

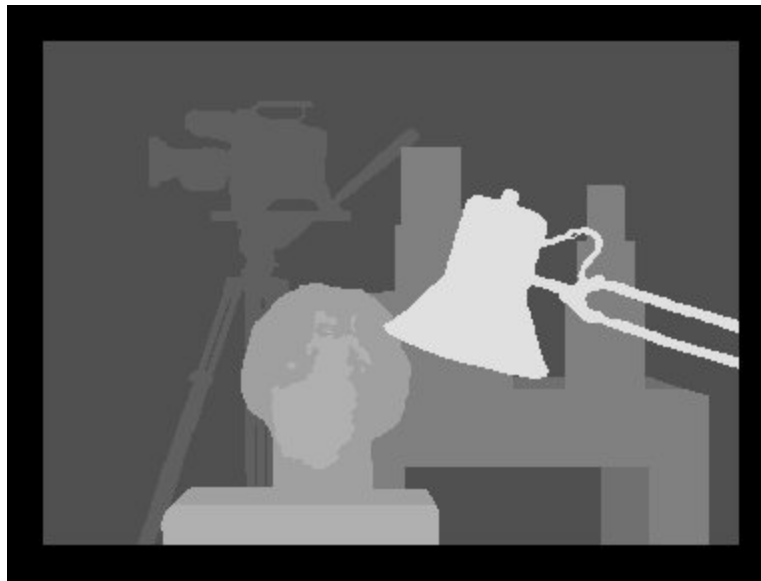



# Stereo Vision

- Goal: Infer information about the 3-D structure and distances of a scene from two or more images taken from different viewpoints.
- A stereo system must solve two subproblems:
  - Correspondence problem
  - Reconstruction
- **Correspondence Problem**: which pixel (point) on the left image and on the right image are projections of the same scene point.
- Once the point correspondence is established, we can compute the relative shift, the **disparity**, between the two projections.
- **Reconstruction**: The disparity data is then converted to a 3D map. In order to transform the disparity data to 3D measurements, we need some form of knowledge about the geometry of the stereo system.



# Depth from Binocular Disparity

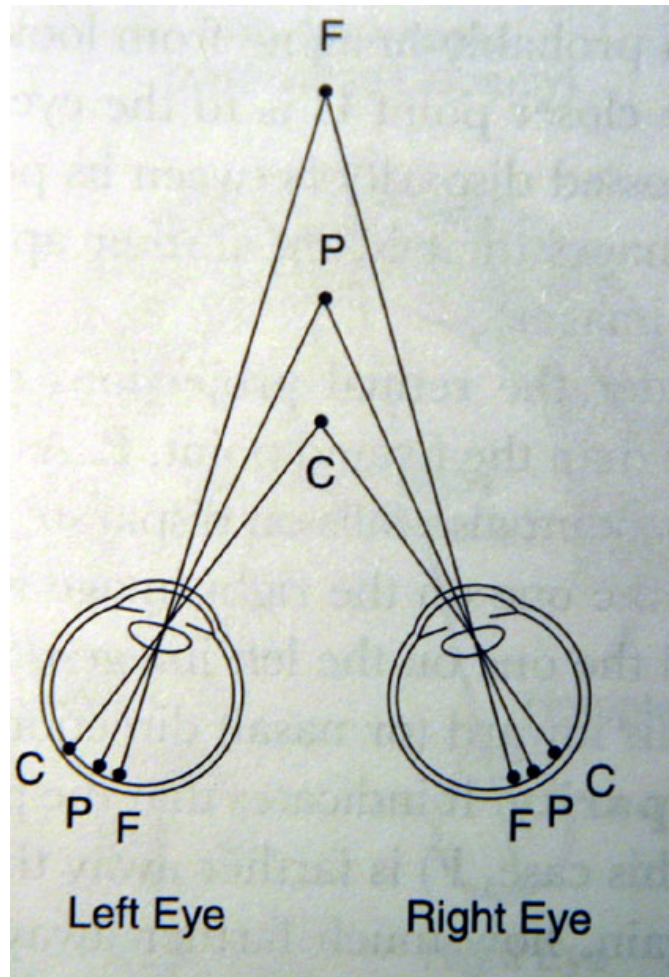

P: converging point

C: object nearer  
projects to the  
outside of the P,  
disparity = +

F: object farther  
projects to the  
inside of the P,  
disparity = -

Sign and magnitude of disparity



# Depth from Convergence

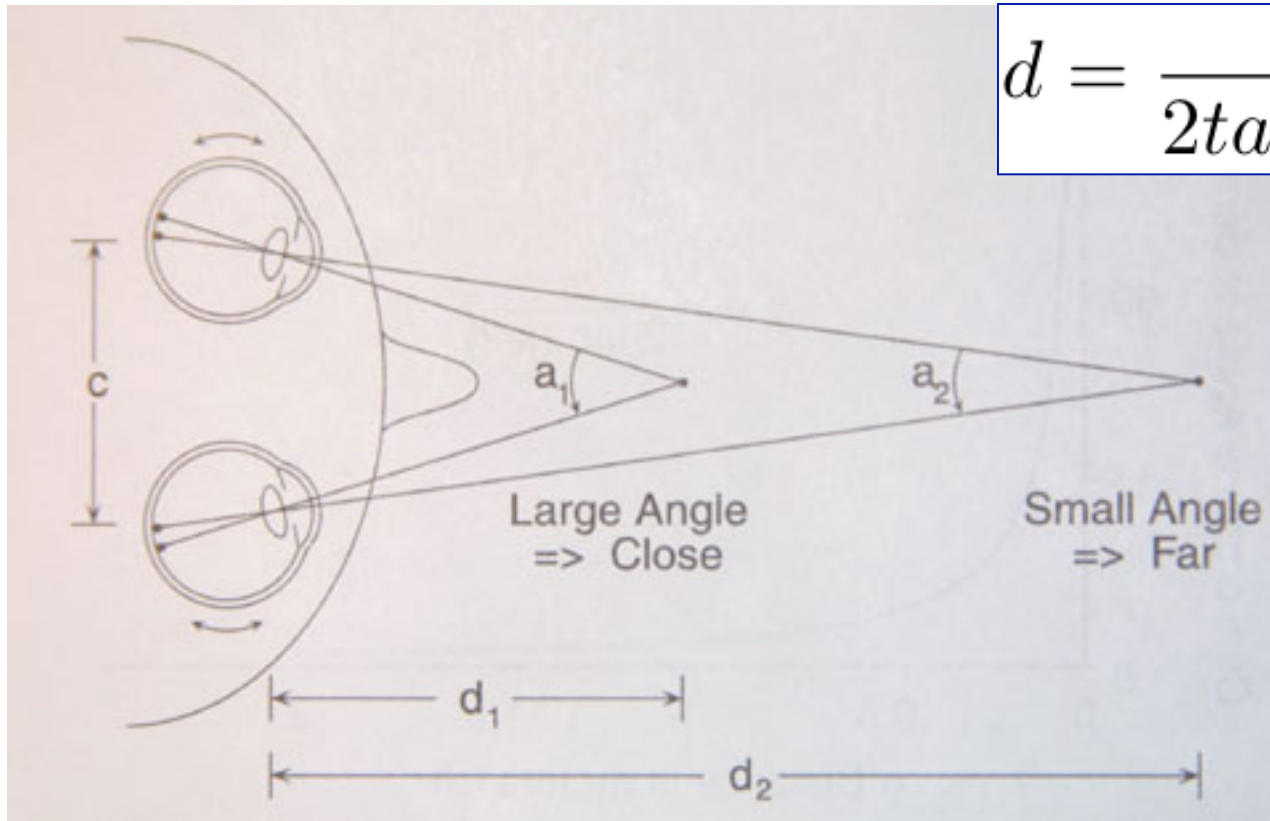

$$d = \frac{c}{2 \tan(a/2)}$$

Human performance: up to 2-2.5 meters



# Simple Binocular Stereo Setup

- Parallel optic axes, i.e. the fixation point (the point where the 2 optic axes intersect) is at infinity.
- Both image planes lie on the same plane.
- Their scan lines are aligned (scan-line coherence), i.e.  $y_L = y_R$ .

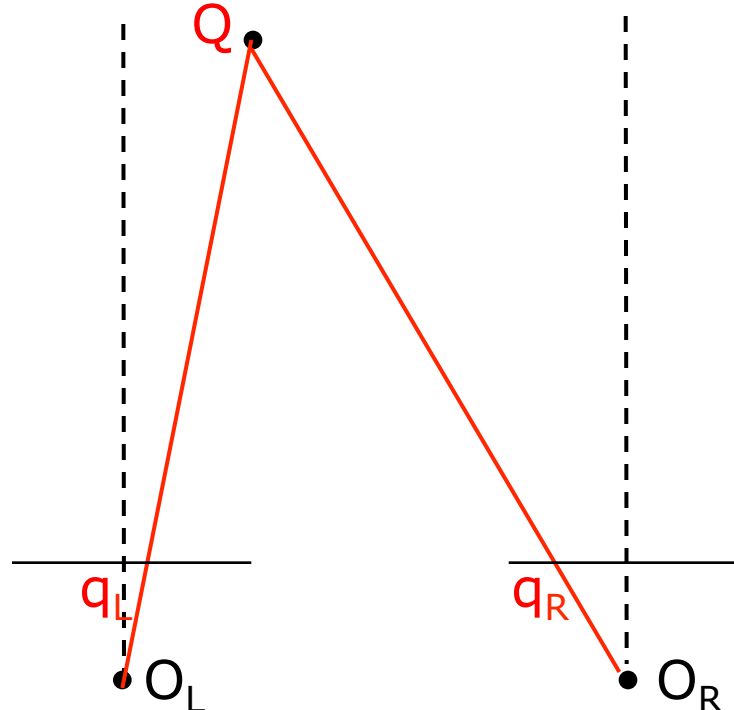



# Correspondence and Triangulation

- When we correspond correctly (i.e.  $q_L$  with  $q_R$  and  $p_L$  with  $p_R$ ), the intersection of the corresponding rays gives the 3D location of scene point that generated the projections (i.e. Q and P accordingly).

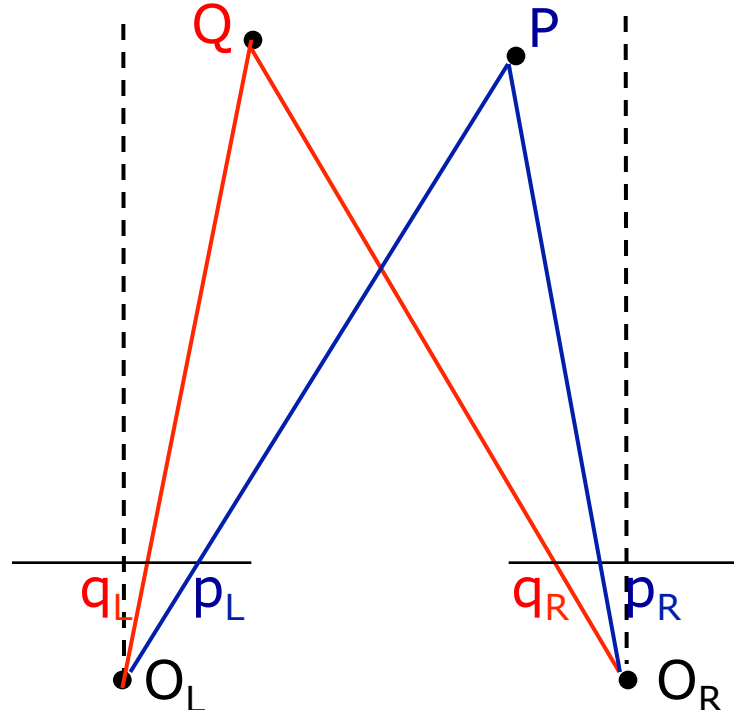



# Impact of Correspondence

- A mistake in correspondence, e.g.  $q_R$  is matched with  $p_L$ , will result in the intersection of rays that correspond to projections of distinct points (Q and P). As a result the wrong 3D location is recovered.

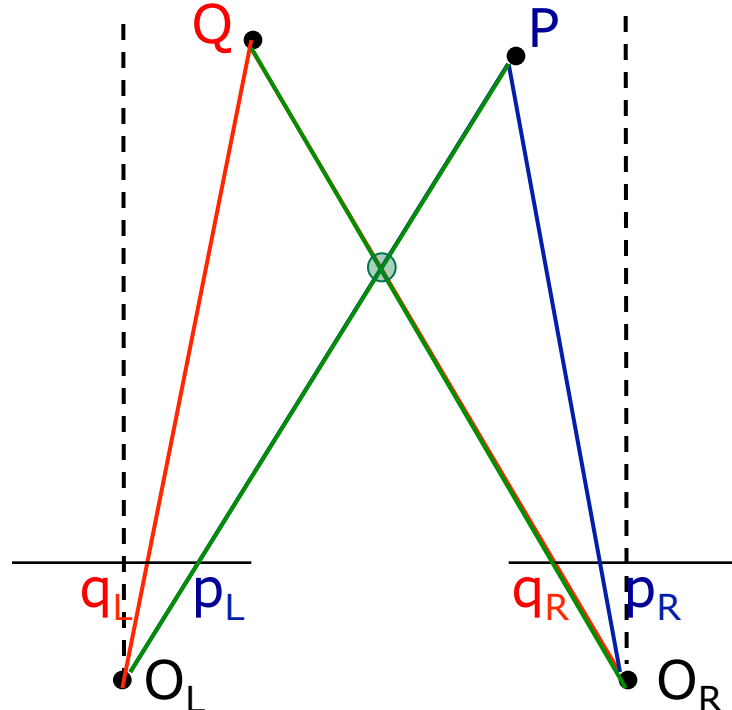





# Noise and Correspondence

- The noise in the image capture process (sensor noise, quantization, discretization) introduces inaccuracies in the projection rays that directly affect the triangulation process.

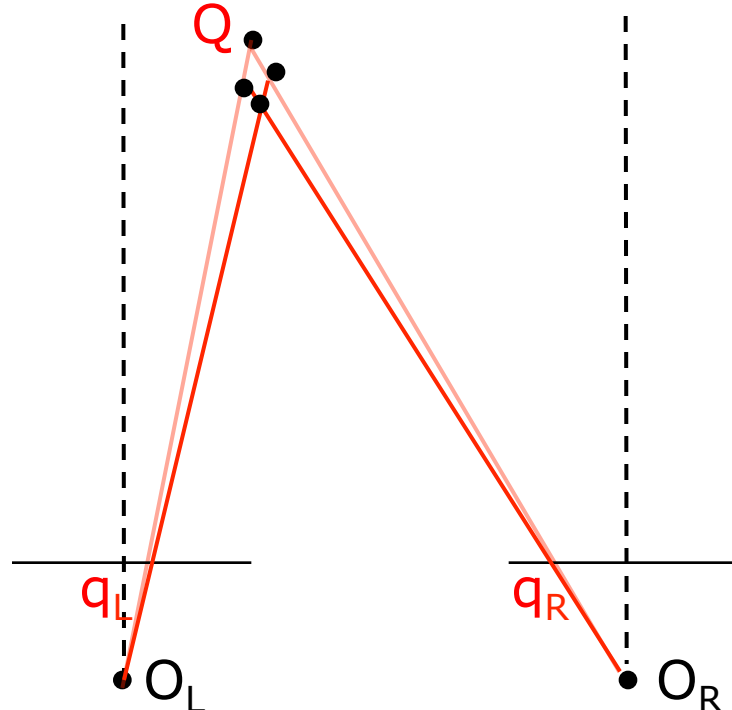

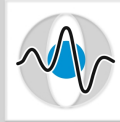

# Triangulation

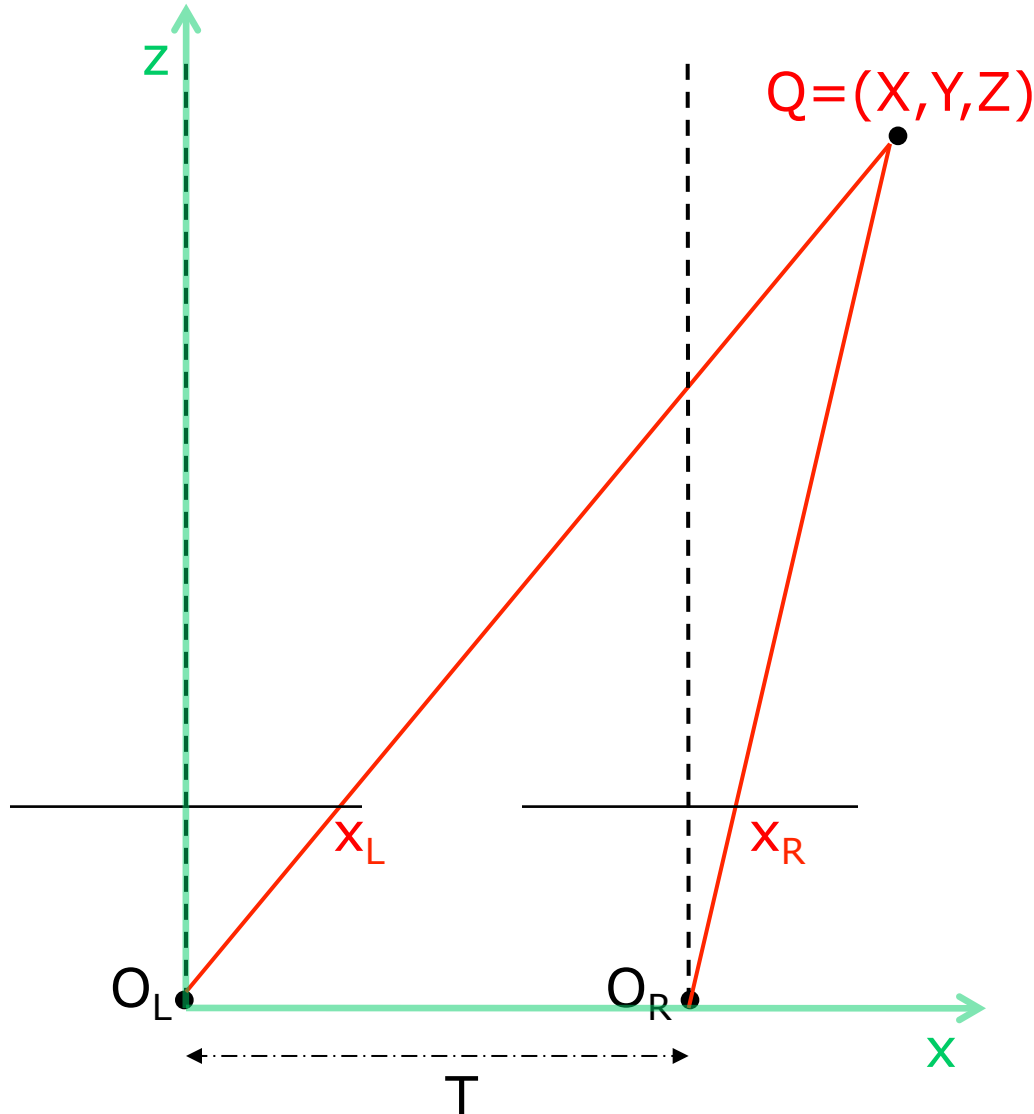

- Assume that the correspondence has been correctly established.
- Under the simple binocular setup (parallel optic axes and scan-line coherence), the only difference between the two projections  $q_L$  and  $q_R$  is in the x-component, i.e.  $x_L$  versus  $x_R$ .
- Let  $T$  be the **baseline**, i.e. the distance between the two COPs.

# Triangulation

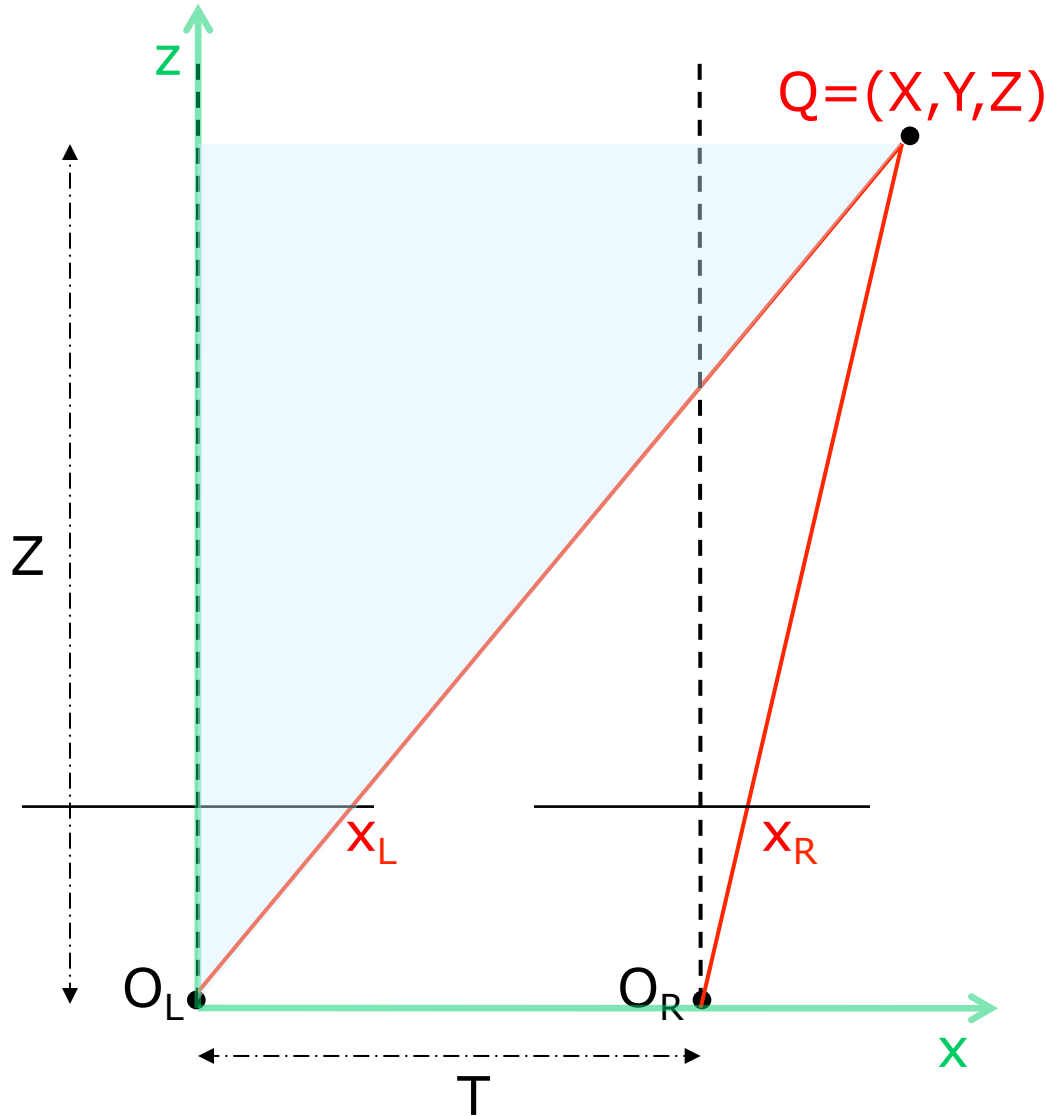



# Triangulation

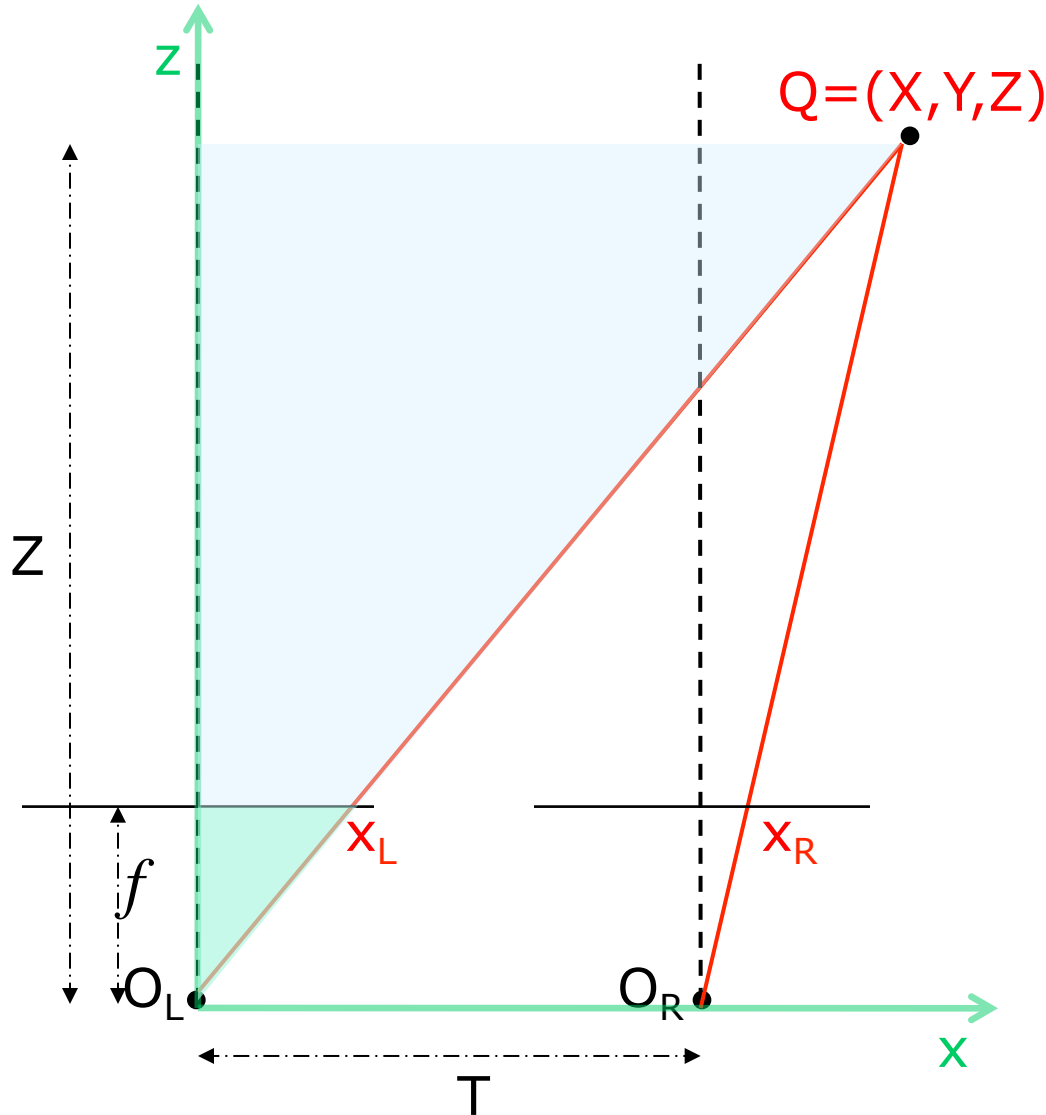

From the similar triangles:

$$\frac{x_L}{f} = \frac{X}{Z} \Rightarrow X = x_L \frac{Z}{f}$$



# Triangulation

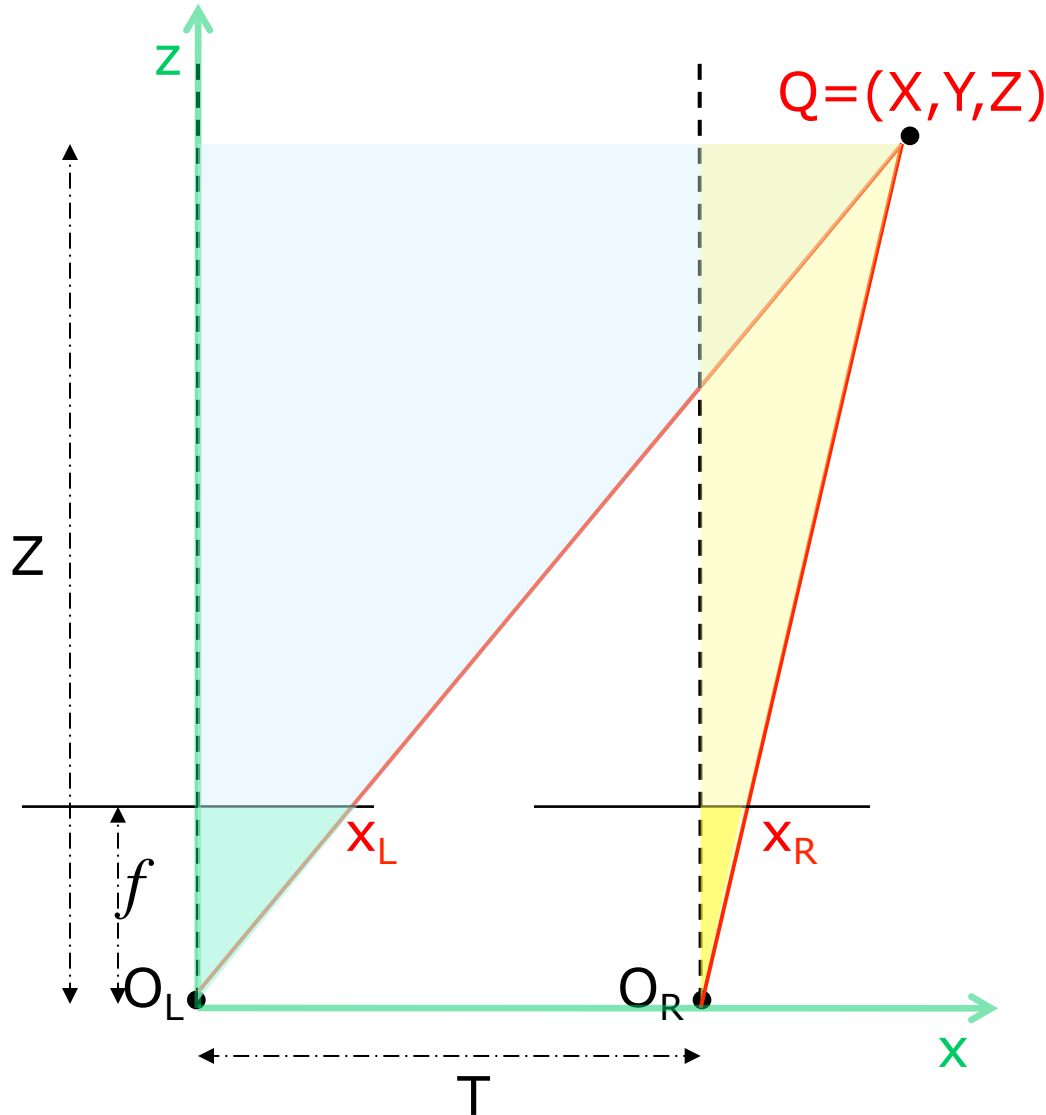

From the similar triangles:

$$\frac{x_L}{f} = \frac{X}{Z} \Rightarrow X = x_L \frac{Z}{f}$$

From the 2<sup>nd</sup> set of similar triangles:

$$\frac{x_R}{f} = \frac{X - T}{Z}$$

By replacing X in the 2<sup>nd</sup> eq.:

$$\frac{x_R}{f} = \frac{x_L \frac{Z}{f} - T}{Z} \Rightarrow x_R Z = x_L Z - fT$$

$$\Rightarrow Z = f \frac{T}{x_L - x_R} = f \frac{T}{d}$$

where  $d$  is the *disparity*:

$$d = x_L - x_R$$



# Impact of Baseline

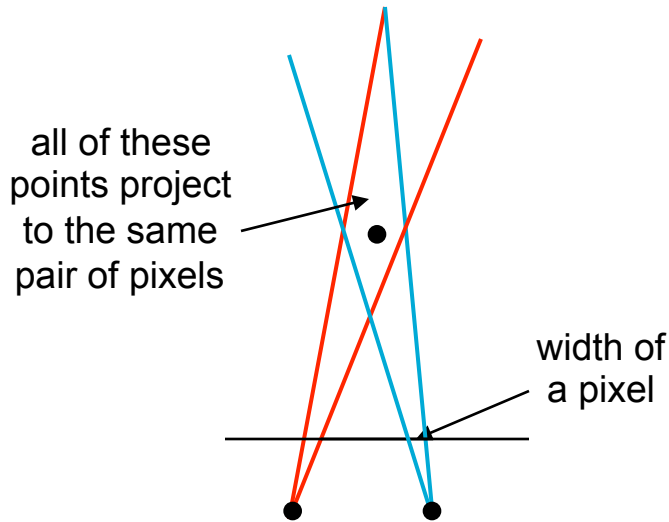

**Small Baseline**

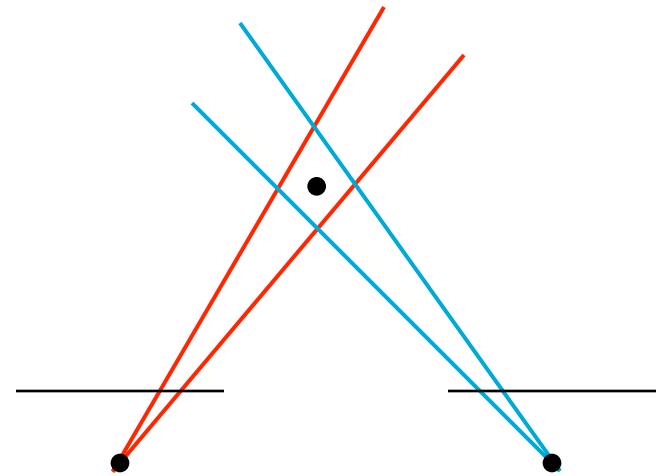

**Large Baseline**

## ■ What's the optimal baseline?

- Too small: large depth error
- Too large: difficult search problem
  - Appearance may change between the 2 viewpoints
  - Decrease in the region of the scene that is mutually visible.



# Vergence

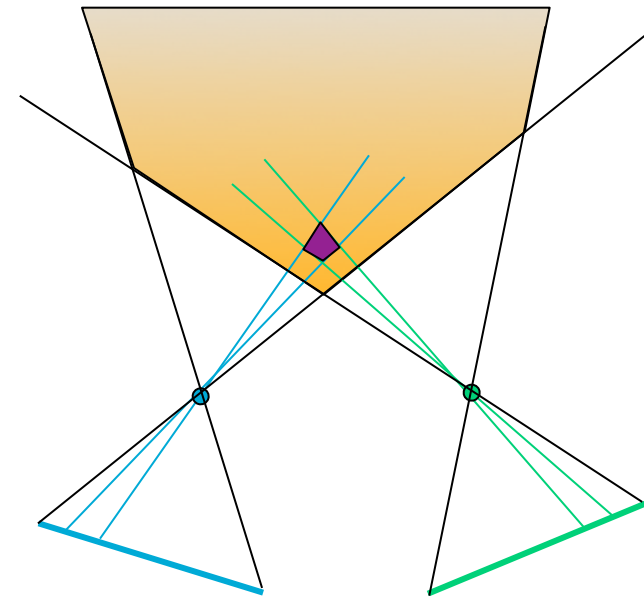
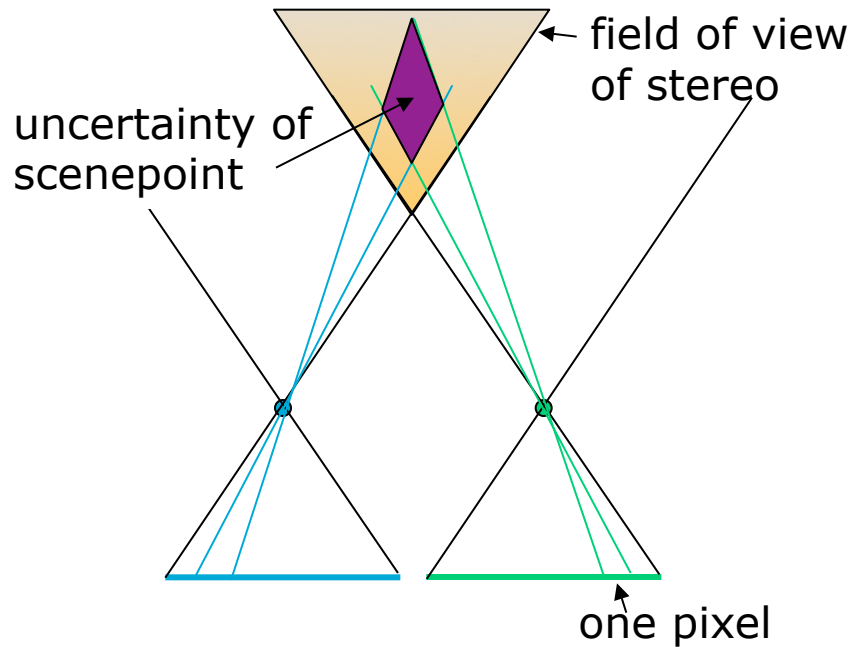

Optical axes of the two cameras need not be parallel

## ■ Solution: Vergence (turn cameras towards each other)

- Increases the field of view
- Increases accuracy in the correspondence

# Stereo Image Rectification



- So far we have assumed:
  - parallel optic axes
  - scan-line coherence
- Such a setup can lead to inaccuracies.
- More commonly cameras are *verged*, i.e. the 2 optic axes intersect each other.
- Can we use the same math?

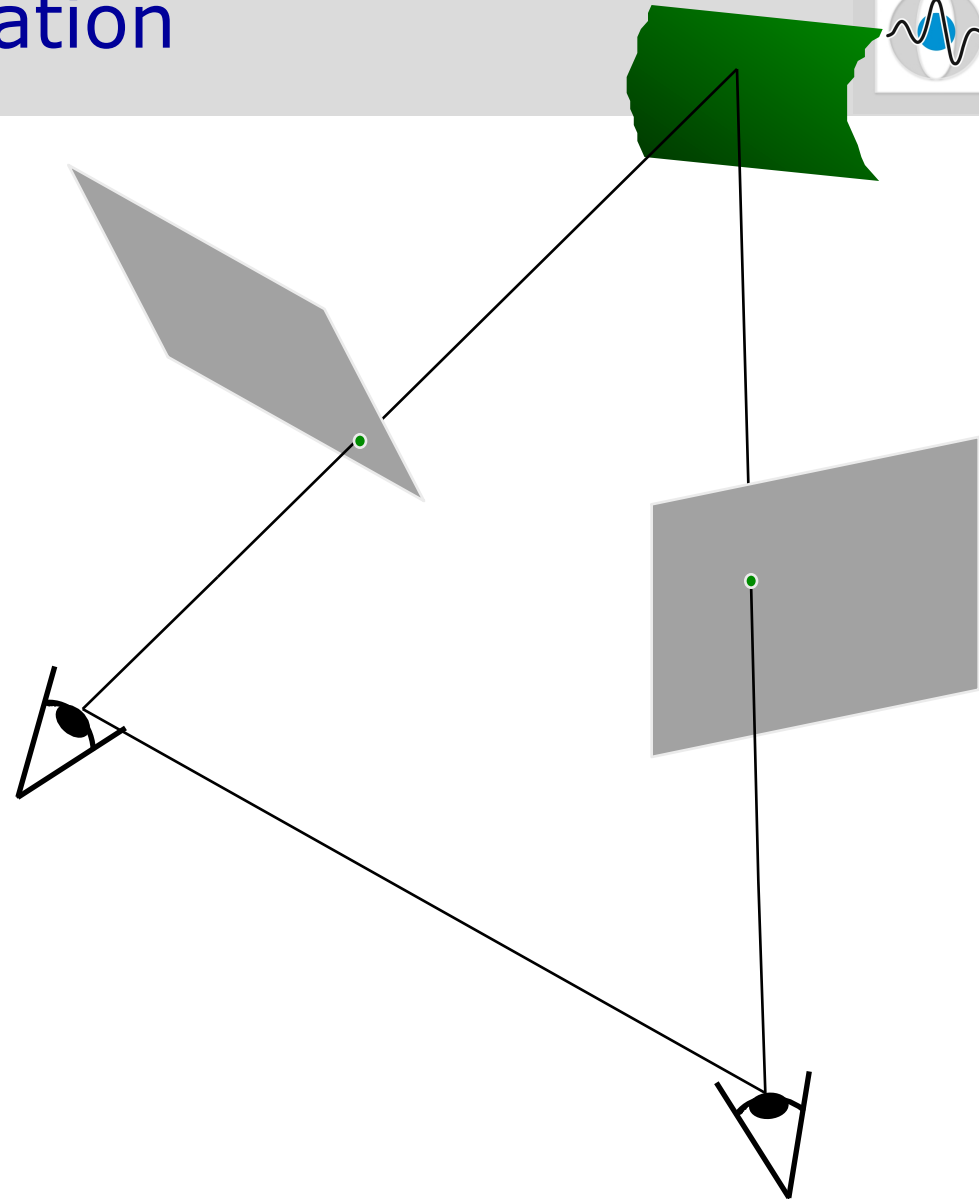



# Stereo Image Rectification



- Yes!
- Re-project the image planes onto a common plane parallel to the baseline (the line between the two centers of projection).
- Two virtual image planes are created, which are now scan-line coherent.
- Do all the computations on these rectified (virtual) image planes.

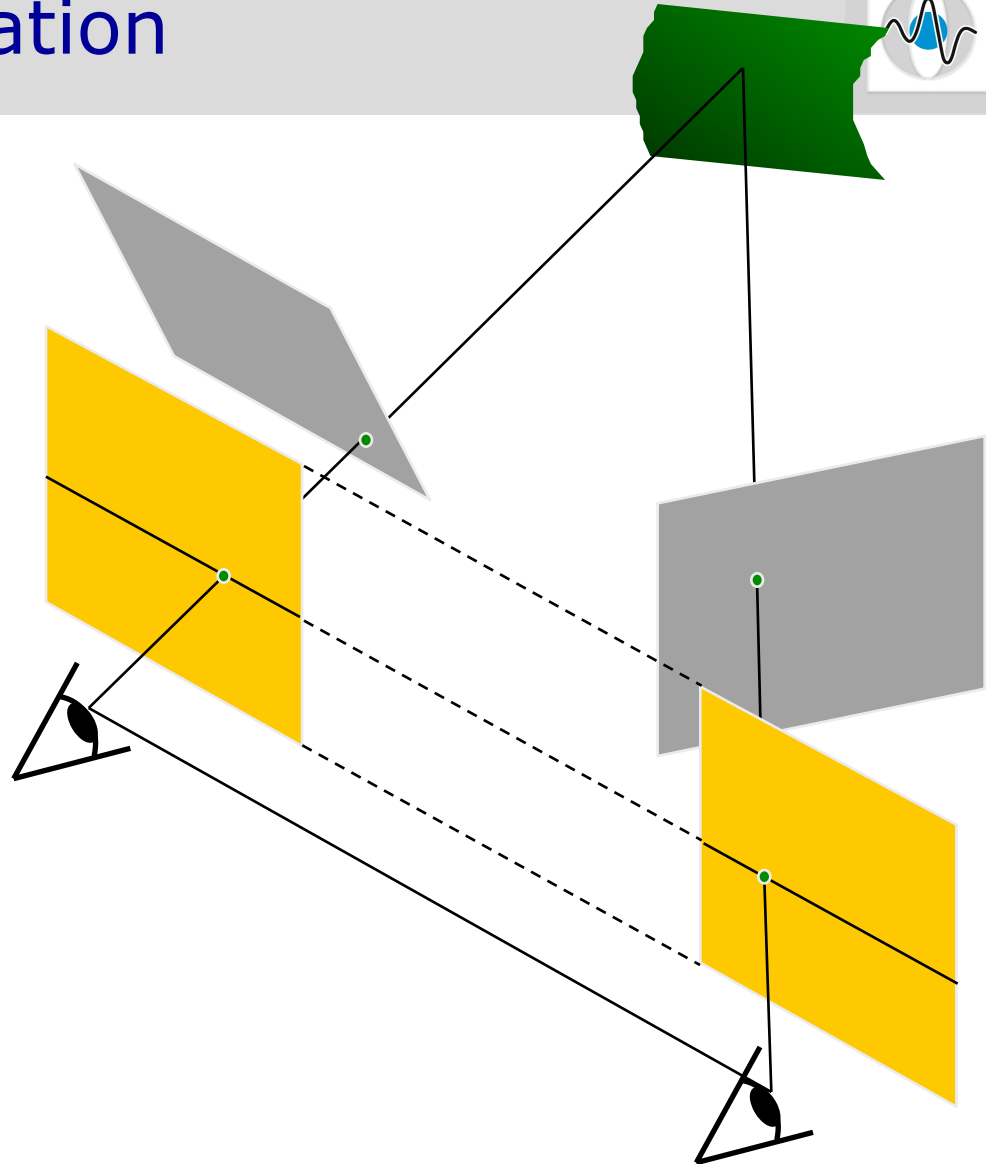



# Stereo Rectification Example

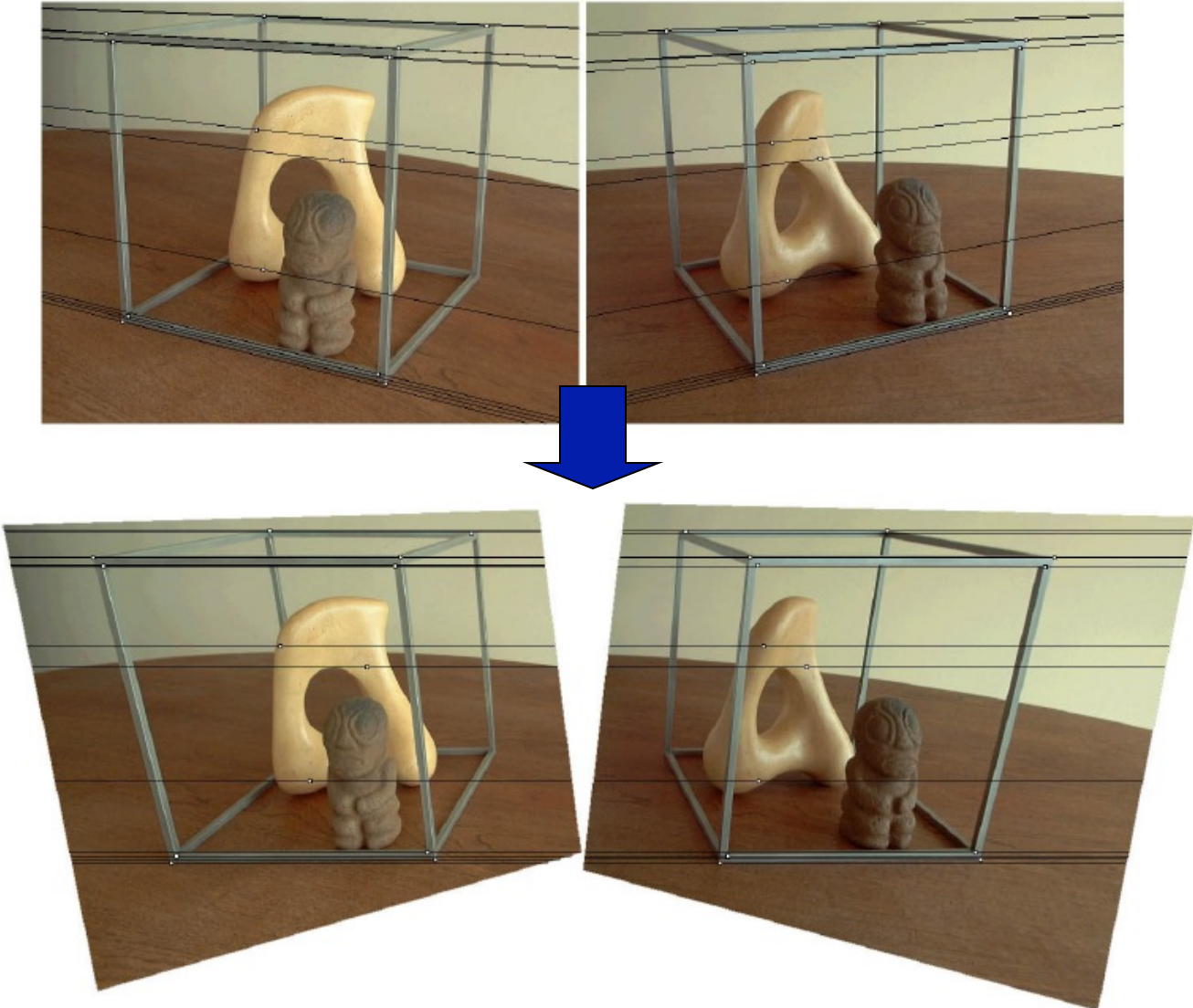



# Correspondence Problem

- **Assumptions:**
  - Most scene points are visible from both viewpoints
  - Corresponding image regions look similar
- **It is a search problem:** Given an element in the left image, search the right image to find the corresponding element.
- **Three underlying questions:**
  1. What do we match between the two images? (objects, edges, pixels, sets of pixels?)
  2. What measure of similarity do we use?
  3. Can we search in a systematic way?

# Point Correspondence



## Random dot stereograms

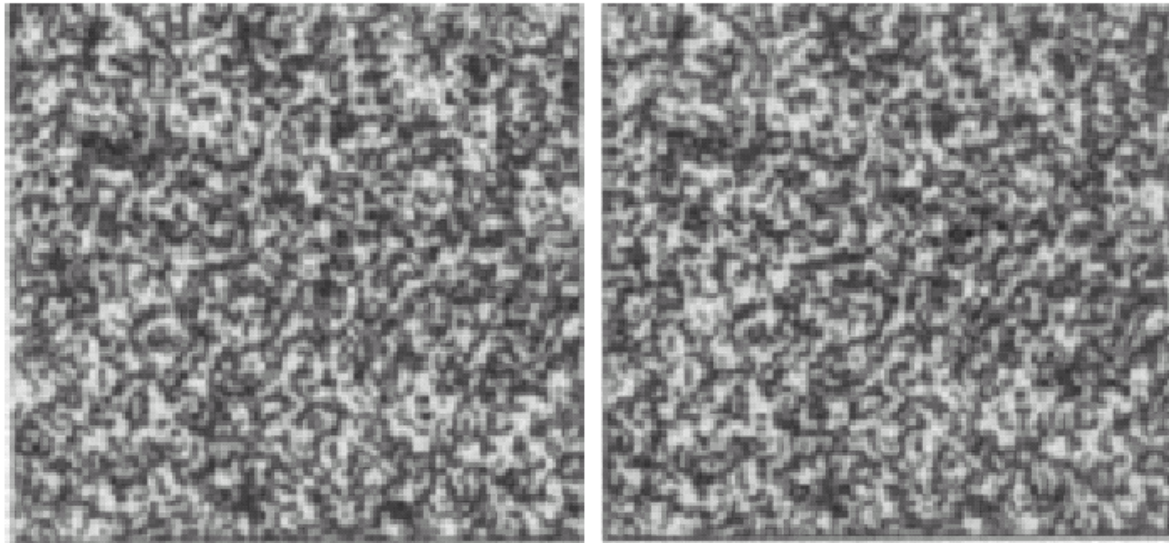

Julesz: had huge impact because it showed that recognition not needed for stereo.



# Point Correspondence in Practice

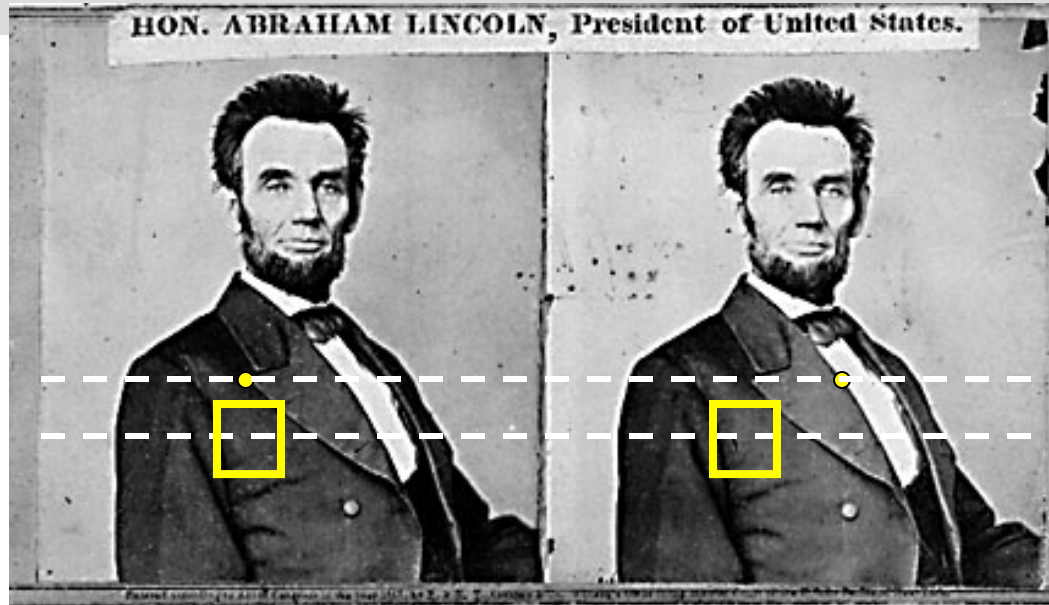

For each scan-line (more properly epipolar line)

For each pixel in the left image

- compare with every pixel on same epipolar line in right image
- pick pixel with closest intensity value (or more general minimum match cost).
- This will never work, so:

Improvement: match **windows**



# Compare Regions around Points

- Idea: Compare intensity profiles around neighborhoods of potential points.
- Elements to be matched are now image windows of fixed size.
- The similarity measure is the correlation between windows in the two images.



# Similarity Metrics

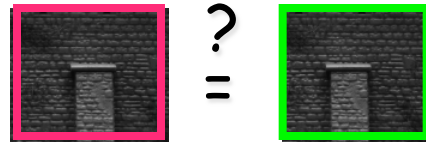

$$SSD = \sum_{[i,j] \in R} (f(i,j) - g(i,j))^2$$

$$C_{fg} = \sum_{[i,j] \in R} f(i,j)g(i,j)$$

$$NC_{fg} = \frac{1}{n-1} \sum_{[i,j] \in R} \frac{(f(i,j) - \bar{f})(g(i,j) - \bar{g})}{\sigma_f \sigma_g}$$

Most  
popular

For each window, match to the closest window on the horizontal (epipolar) line in the other image.



# Window Size



$W = 3$

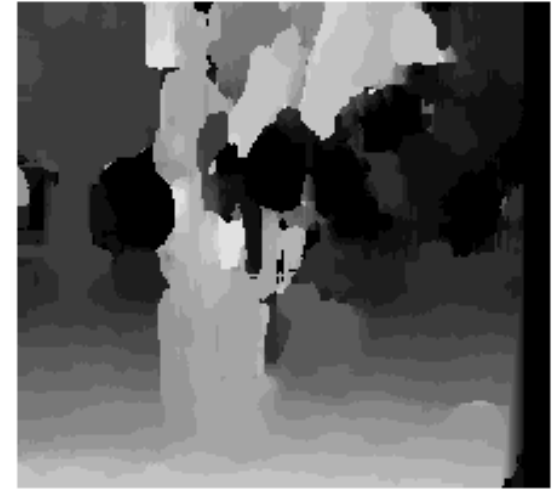

$W = 20$

- Smaller window: more detail, more noise.
- Larger window: less noise, less detail
- Better results with adaptive window size





# Hierarchical Correspondence

- Allows faster computation
- Can handle large disparity ranges

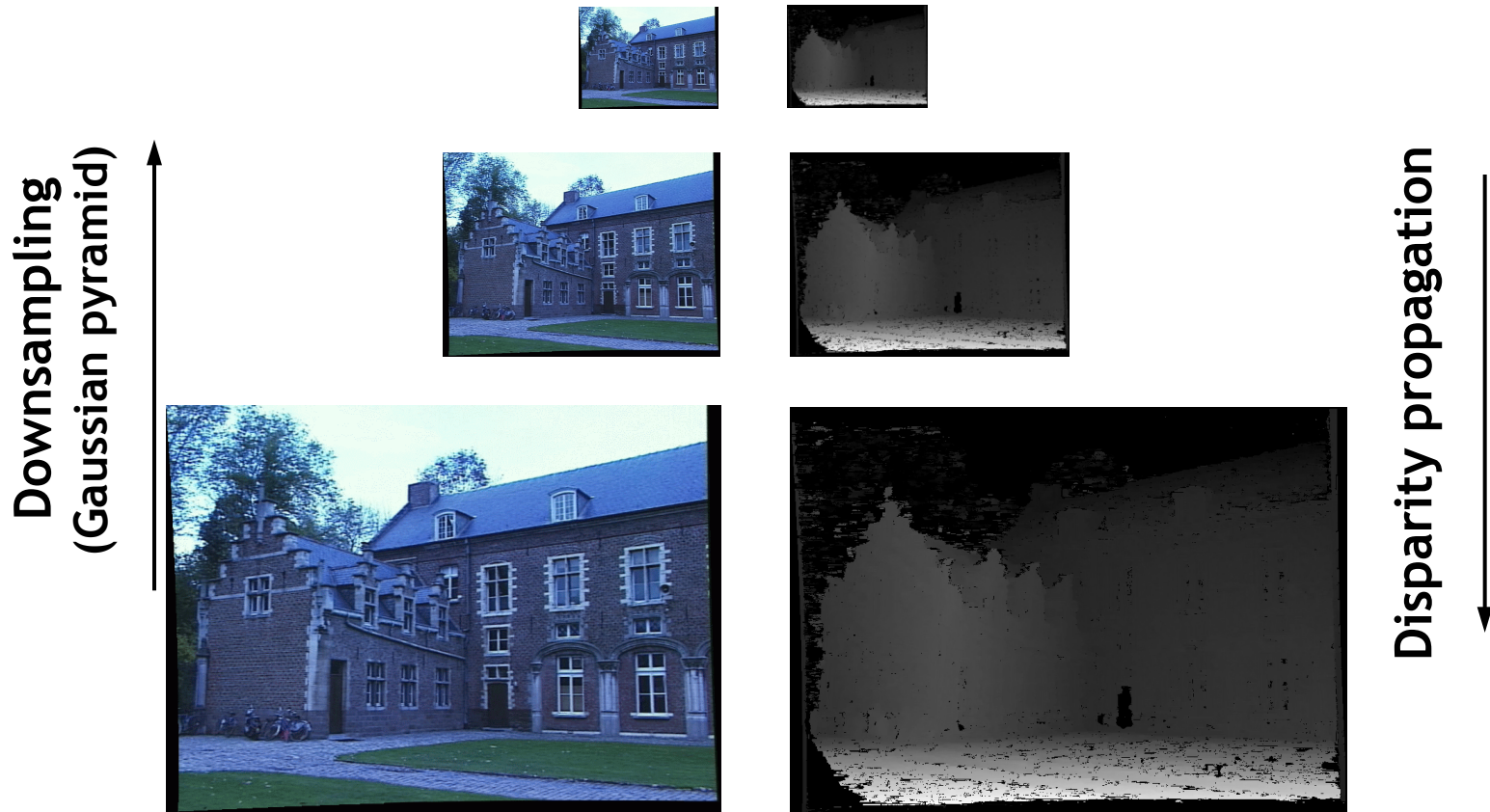



# Compare Features

- Another Idea: Compute features and match only pixels based on their feature values.
- Possible features:
  - Edges
  - Lines...
- Pros: Possibly more unique values => easier correspondence
- Cons: Not all the pixels have a feature value => sparse correspondence; need for interpolation
- Often used in combination with hierarchical correspondence.

# Stereo Example



left image



right image



depth map

H. Tao et al. "[Global matching criterion and color segmentation based stereo](#)"



# Reconstruction



# Image Sources



1. The slides on image rectification are courtesy of J. Chai,  
[http://faculty.cs.tamu.edu/jchai/cpsc641\\_spring10/lectures/lecture9.ppt](http://faculty.cs.tamu.edu/jchai/cpsc641_spring10/lectures/lecture9.ppt)
2. A number of slides in this presentation have been adapted by the presentation of S. Narasimhan,  
<http://ww.cs.cmu.edu/afs/cs/academic/class/15385-s06/lectures/ppts/lec-14.ppt>
3. The Lincoln image is courtesy of S. Seitz.
4. The window-matching slide is courtesy of O. Camps.
5. The example slide on hierarchical correspondence algorithms is courtesy of ETH,  
<http://www.inf.ethz.ch/personal/pomarc/courses/qcv/class07.ppt>