

Estimation of Regional Electrical Properties of the Heart from 12-Lead ECG and Images

Philipp Seegerer

19.05.2014

Pattern Recognition Lab (CS 5)



FRIEDRICH-ALEXANDER
UNIVERSITÄT
ERLANGEN-NÜRNBERG

TECHNISCHE FAKULTÄT



Outline

Introduction

Cardiac Motion Estimation

Electrophysiology Modeling

Evaluation

Conclusion and Outlook

Introduction



FRIEDRICH-ALEXANDER
UNIVERSITÄT
ERLANGEN-NÜRNBERG

TECHNISCHE FAKULTÄT

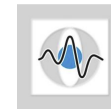

Cardiac Anatomy

- Blood flow by contraction of myocardium
- Myocardium encased by endocardium and epicardium
- Divided into two parts by septum
- Each half divided into atrium and ventricle
- Short axis view

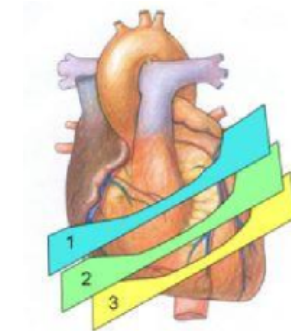
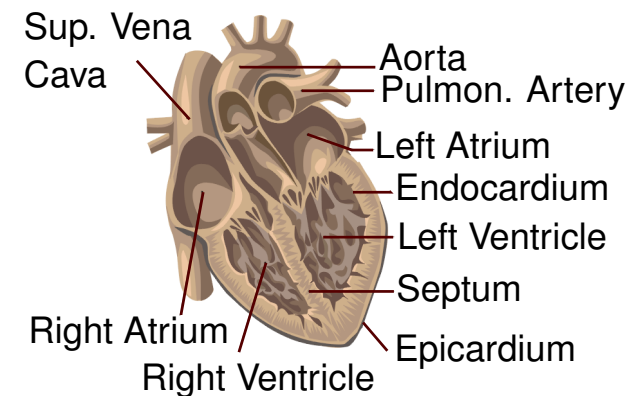

Short Axis Slices

Figures:

Top: Courtesy of Family Practice Notebook (<http://www.fpnotebook.com/>)

Bottom: Courtesy of Stanford University (<http://www.stanford.edu/>)

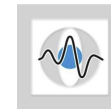

Cardiac Electrophysiology

- Electrical stimulation
→ Heart muscle contraction
- Cardiac conduction system
- Varying conduction velocity
- Healthy heart: uniform wave propagation

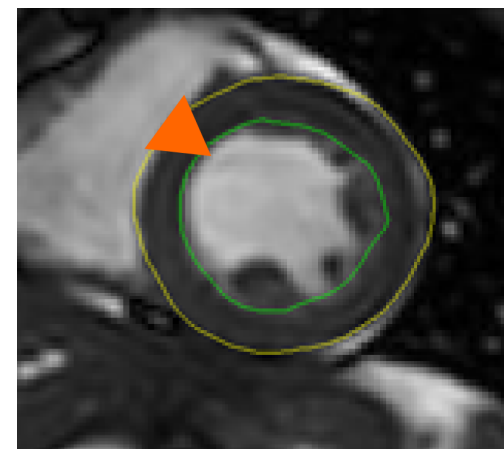
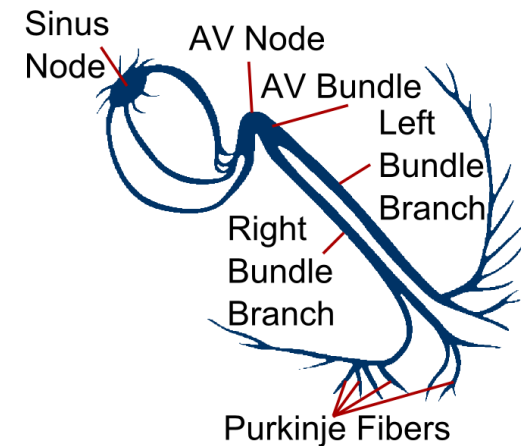

Figures:

Top: Courtesy of Wikipedia (<http://com.wikipedia.org/>)



Cardiac Electrophysiology

- Electrical stimulation
→ Heart muscle contraction
- Cardiac conduction system
- Varying conduction velocity
- Healthy heart: uniform wave propagation

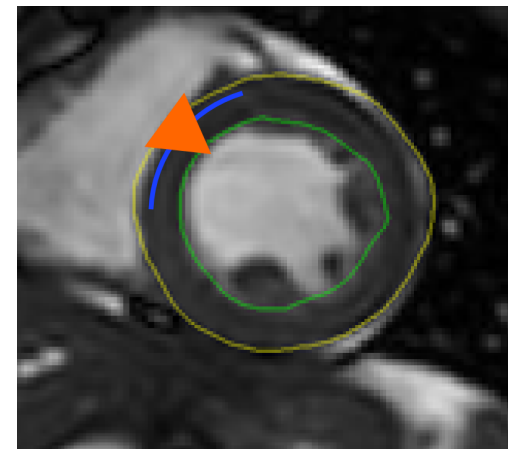
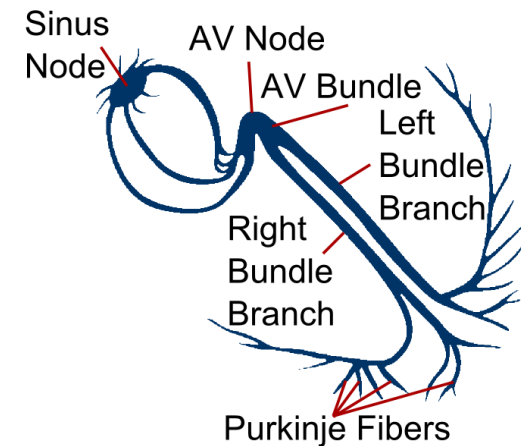

Figures:

Top: Courtesy of Wikipedia (<http://com.wikipedia.org/>)



Cardiac Electrophysiology

- Electrical stimulation
→ Heart muscle contraction
- Cardiac conduction system
- Varying conduction velocity
- Healthy heart: uniform wave propagation

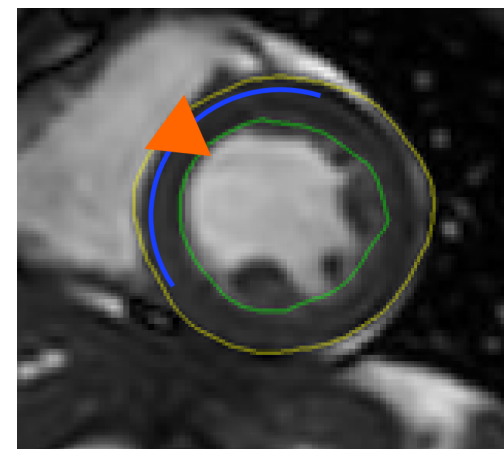
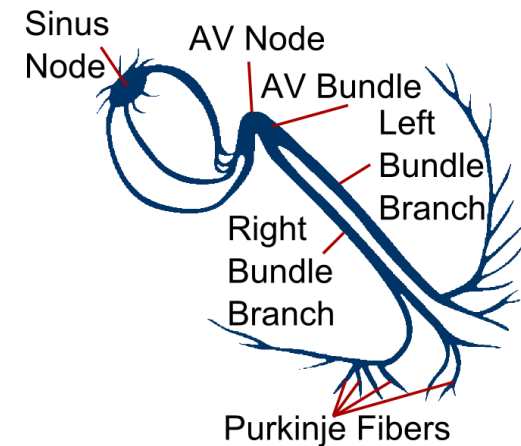

Figures:

Top: Courtesy of Wikipedia (<http://com.wikipedia.org/>)

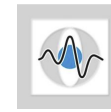

Cardiac Electrophysiology

- Electrical stimulation
→ Heart muscle contraction
- Cardiac conduction system
- Varying conduction velocity
- Healthy heart: uniform wave propagation

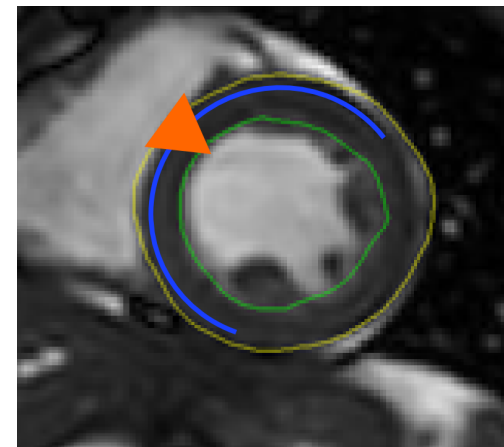
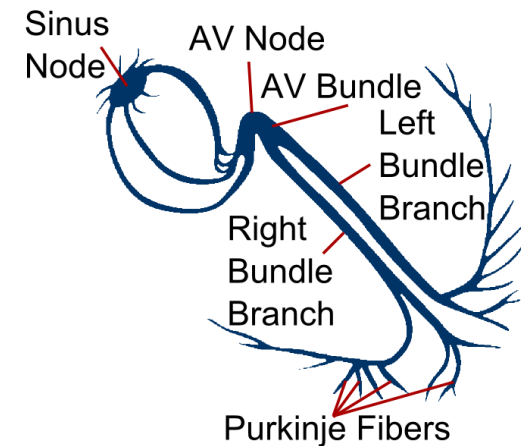

Figures:

Top: Courtesy of Wikipedia (<http://com.wikipedia.org/>)



Cardiac Electrophysiology

- Electrical stimulation
→ Heart muscle contraction
- Cardiac conduction system
- Varying conduction velocity
- Healthy heart: uniform wave propagation

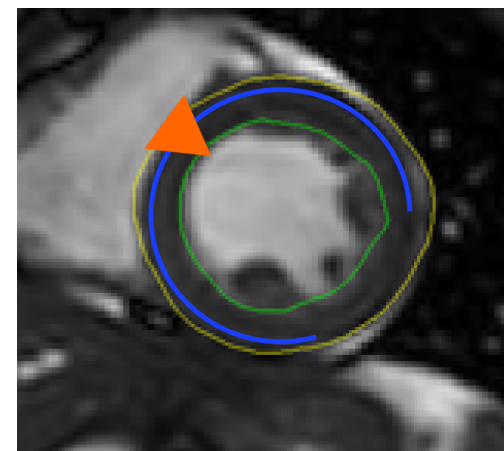
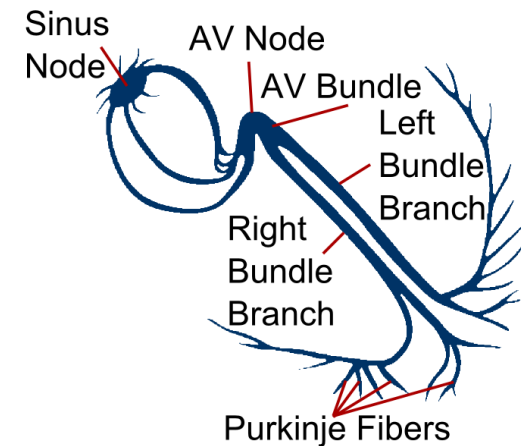

Figures:

Top: Courtesy of Wikipedia (<http://com.wikipedia.org/>)



Cardiac Electrophysiology

- Electrical stimulation
→ Heart muscle contraction
- Cardiac conduction system
- Varying conduction velocity
- Healthy heart: uniform wave propagation

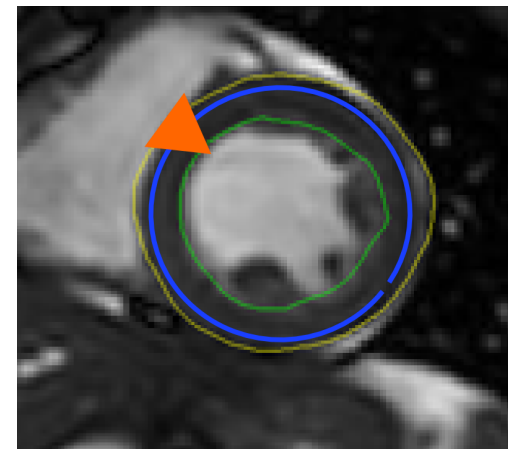
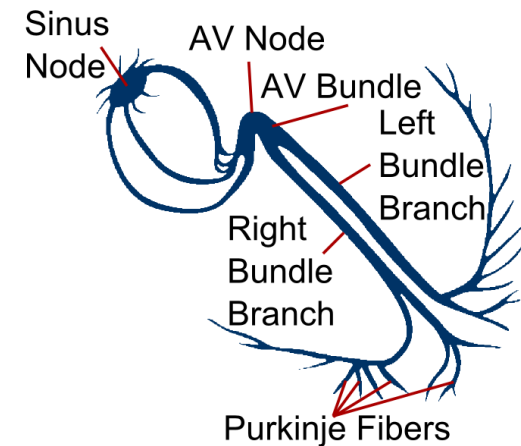

Figures:

Top: Courtesy of Wikipedia (<http://com.wikipedia.org/>)



Cardiac Electrophysiology

- Electrical stimulation
 - Heart muscle contraction
- Cardiac conduction system
- Varying conduction velocity
- Healthy heart: uniform wave propagation
- Left bundle branch block (LBBB)
 - U-shaped propagation pattern

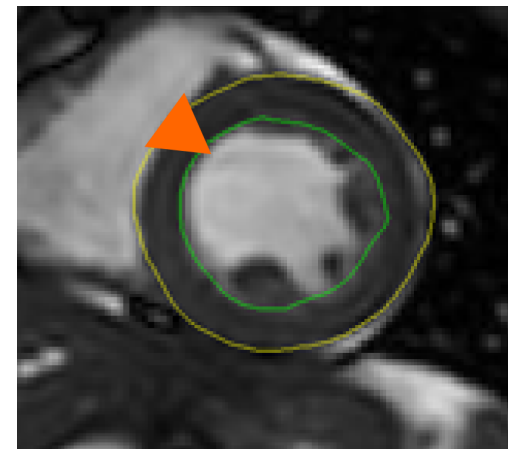
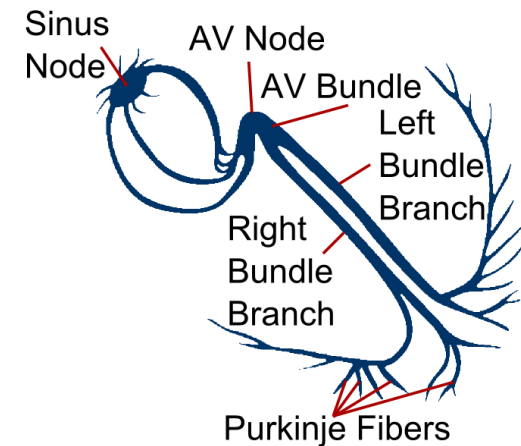

Figures:

Top: Courtesy of Wikipedia (<http://com.wikipedia.org/>)



Cardiac Electrophysiology

- Electrical stimulation
 - Heart muscle contraction
- Cardiac conduction system
- Varying conduction velocity
- Healthy heart: uniform wave propagation
- Left bundle branch block (LBBB)
 - U-shaped propagation pattern

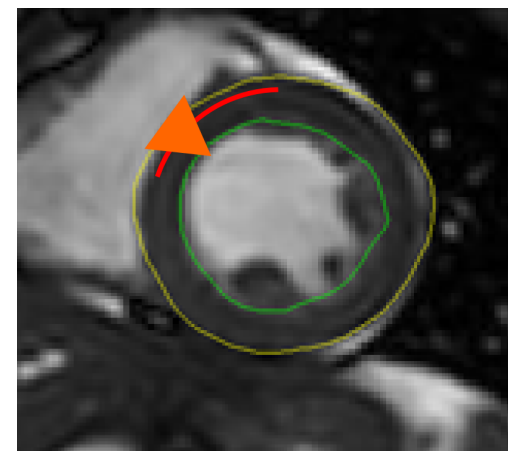
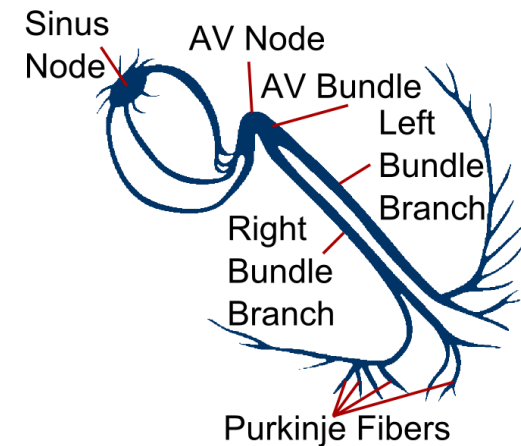

Figures:

Top: Courtesy of Wikipedia (<http://com.wikipedia.org/>)



Cardiac Electrophysiology

- Electrical stimulation
 - Heart muscle contraction
- Cardiac conduction system
- Varying conduction velocity
- Healthy heart: uniform wave propagation
- Left bundle branch block (LBBB)
 - U-shaped propagation pattern

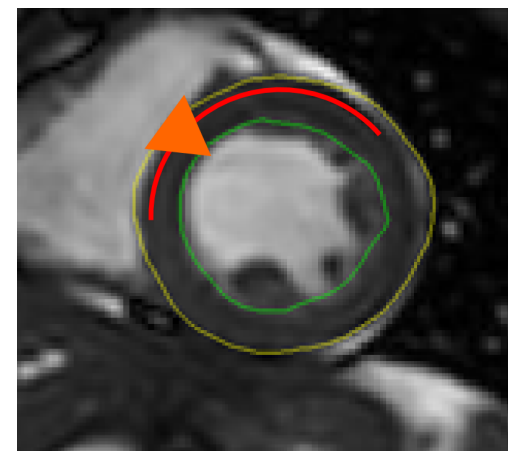
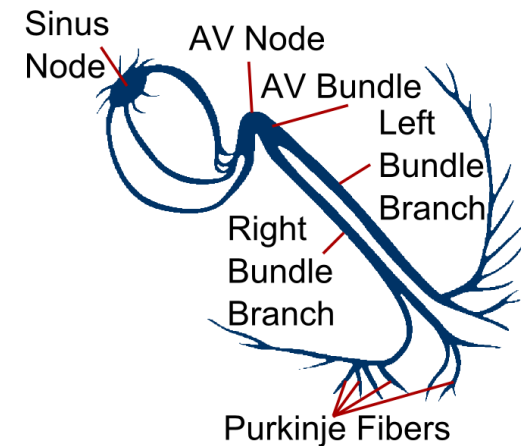

Figures:

Top: Courtesy of Wikipedia (<http://com.wikipedia.org/>)



Cardiac Electrophysiology

- Electrical stimulation
 - Heart muscle contraction
- Cardiac conduction system
- Varying conduction velocity
- Healthy heart: uniform wave propagation
- Left bundle branch block (LBBB)
 - U-shaped propagation pattern

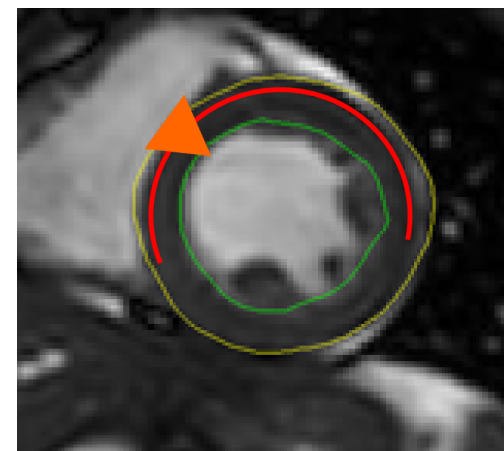
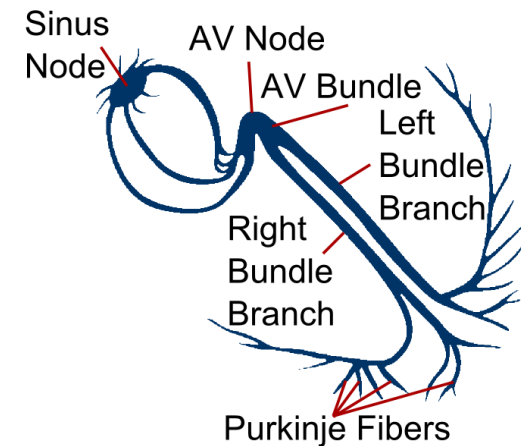

Figures:

Top: Courtesy of Wikipedia (<http://com.wikipedia.org/>)



Cardiac Electrophysiology

- Electrical stimulation
 - Heart muscle contraction
- Cardiac conduction system
- Varying conduction velocity
- Healthy heart: uniform wave propagation
- Left bundle branch block (LBBB)
 - U-shaped propagation pattern

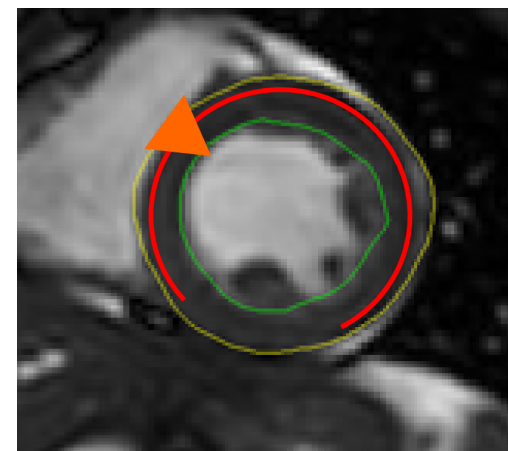
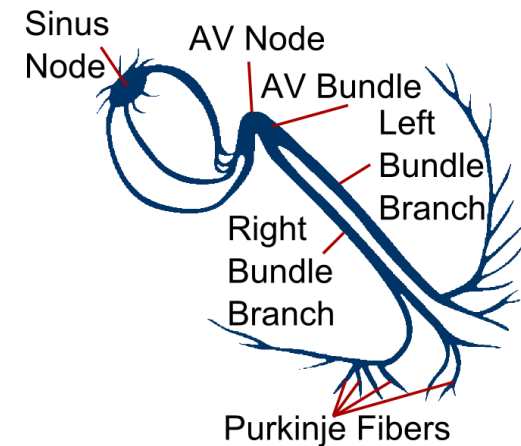

Figures:

Top: Courtesy of Wikipedia (<http://com.wikipedia.org/>)

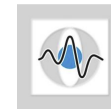

Cardiac Electrophysiology

- Electrical stimulation
 - Heart muscle contraction
- Cardiac conduction system
- Varying conduction velocity
- Healthy heart: uniform wave propagation
- Left bundle branch block (LBBB)
 - U-shaped propagation pattern

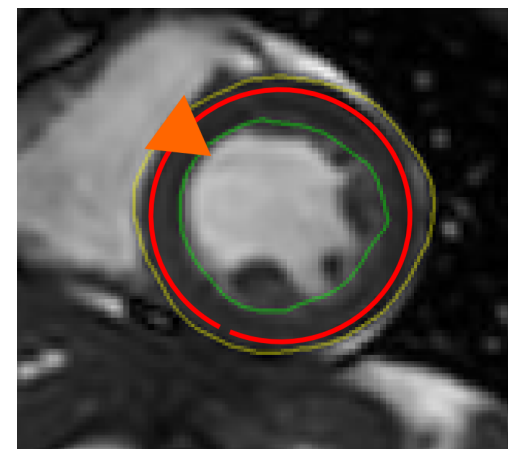
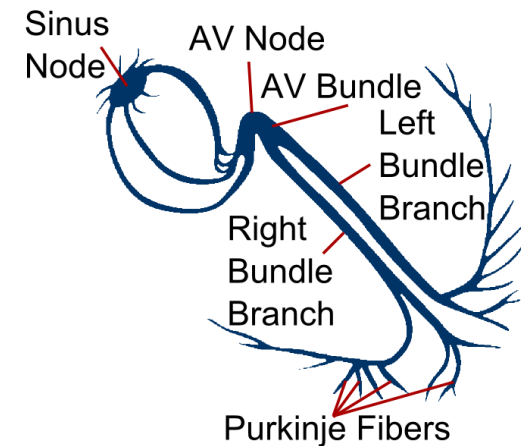

Figures:

Top: Courtesy of Wikipedia (<http://com.wikipedia.org/>)

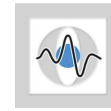

Models of Cardiac Electrophysiology

- Goal: simulation of electrical wave propagation
- Clinical applications
 - Patient selection
 - Therapy planning
 - Outcome prediction

Important: model personalization



State of the Art

Data acquisition for personalization based on:

- Endocardial Mapping [Relan et al., 2011]
- Body Surface Potential Mapping (BSPM) [Doessel et al., 2011]
- 12-lead ECG [Neumann et al., 2014]

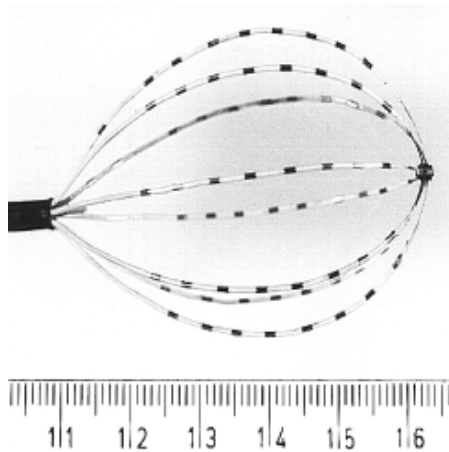

Endocardial Mapping Catheter



BSPM Acquisition



ECG Trace

Figures:

Left: Courtesy of AHA Journals (<http://circ.ahajournals.org/>)

Middle: Courtesy of Rudy Laboratory (<http://rudylab.wustl.edu/>)



Problems

- Endocardial mapping: **invasive**
- Body Surface Potential Mapping: **seldom available**
- 12-lead ECG: **global**

Our solution: 12-lead ECG and motion information for regional properties

Advantages:

- Non-invasive
- Widely available
- Regional



Workflow

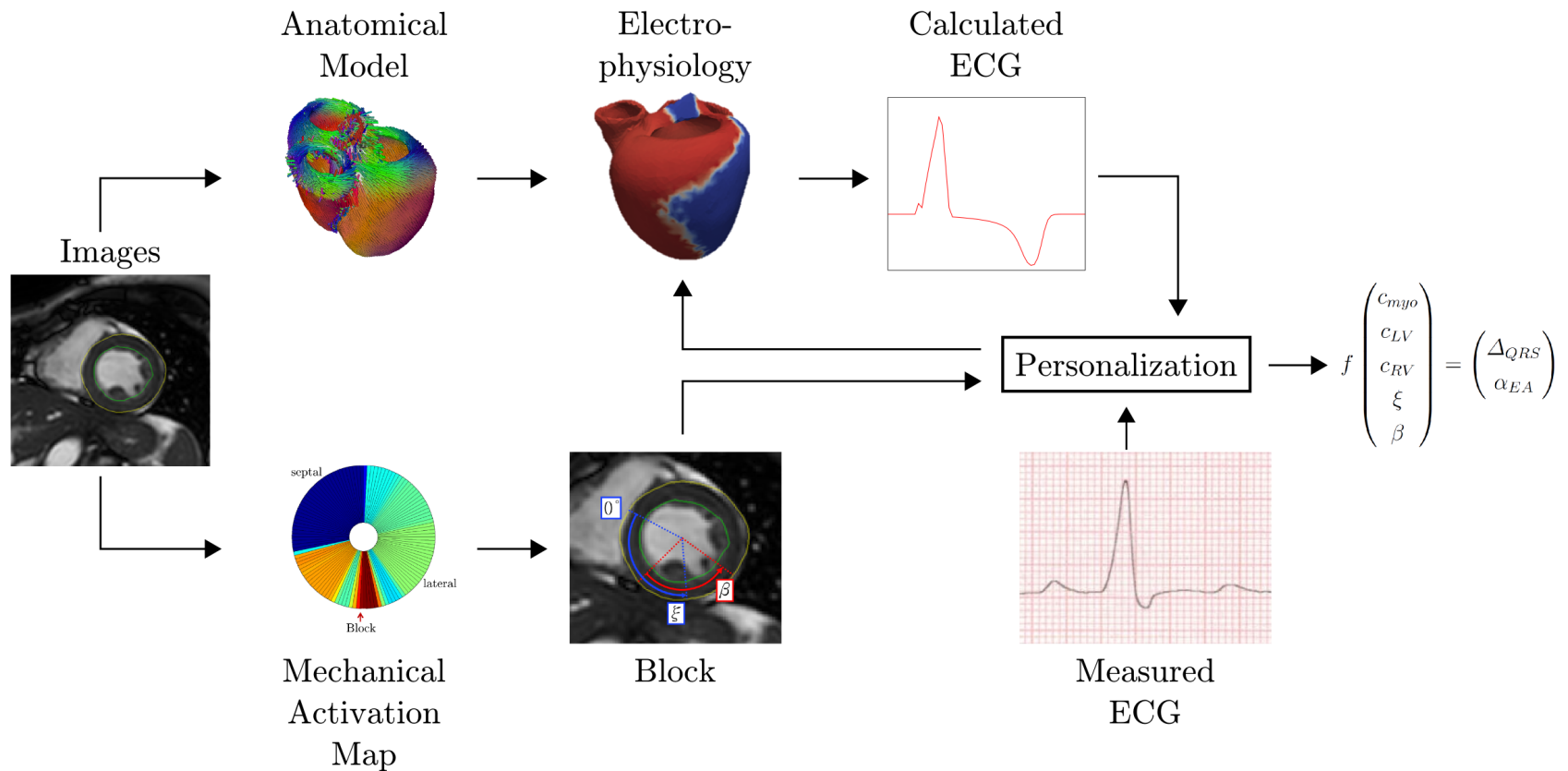

Cardiac Motion Estimation



FRIEDRICH-ALEXANDER
UNIVERSITÄT
ERLANGEN-NÜRNBERG

TECHNISCHE FAKULTÄT



Workflow

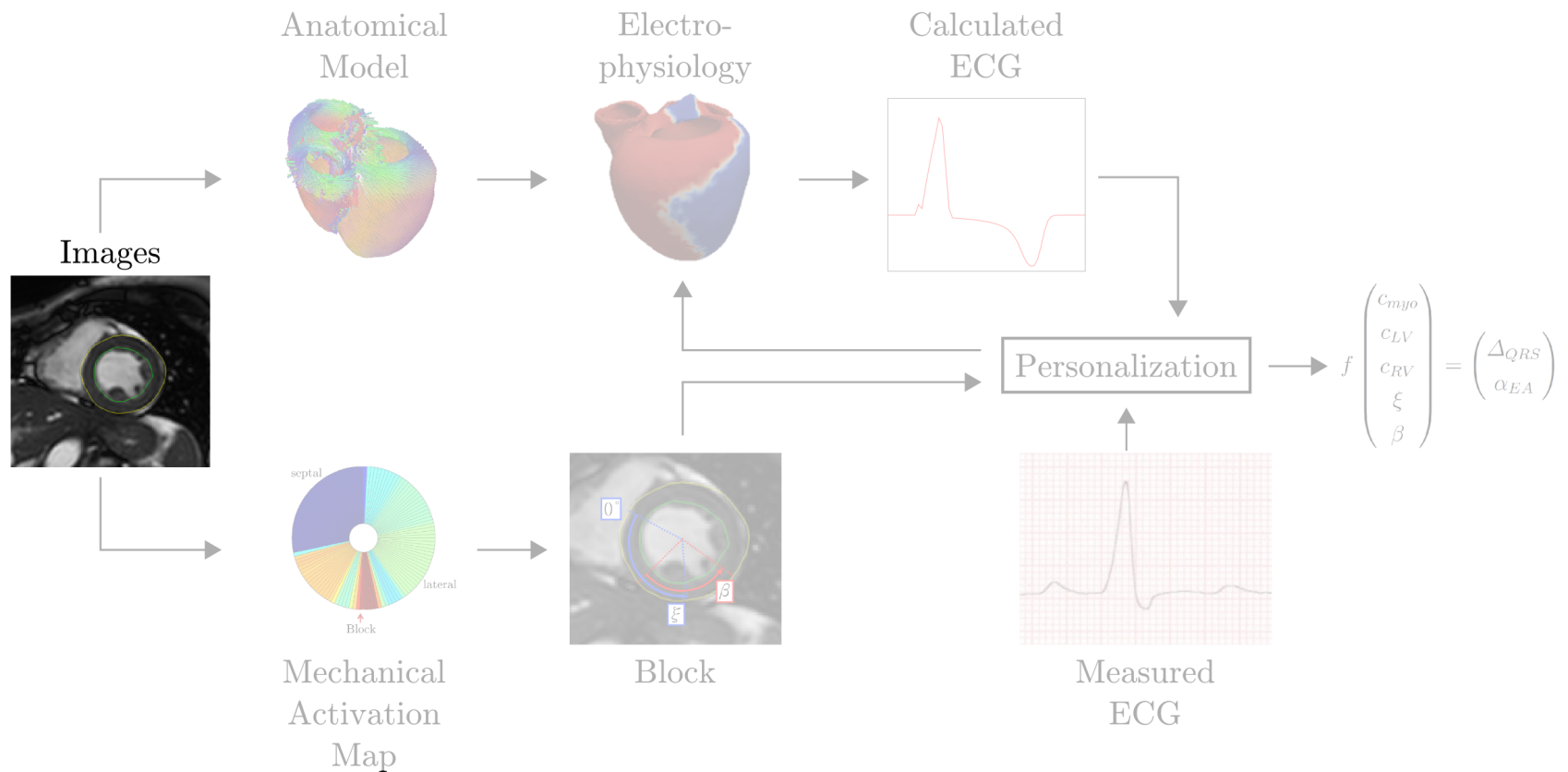
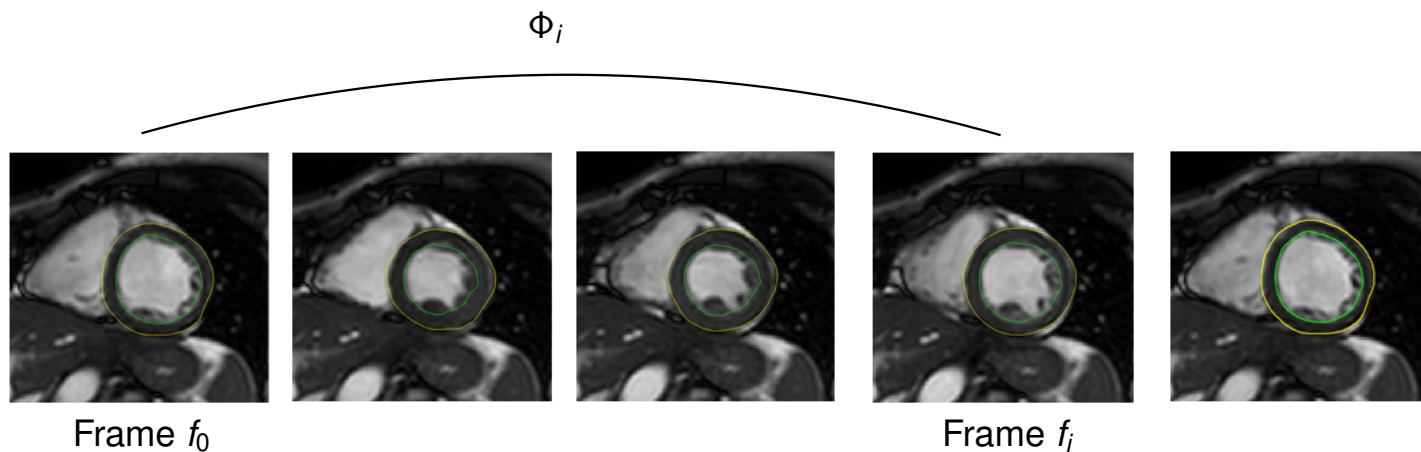



Image Registration and Tracking

- Dynamic cardiac images (Cine MRI)
- Automatic segmentation and tracking of left-ventricular myocardium
- Registration by inverse-consistent, diffeomorphic algorithm [Guetter et al., 2011]
- Dense deformation field Φ_i for each frame f_i
→ Registration to first (end-diastolic) frame f_0





Workflow

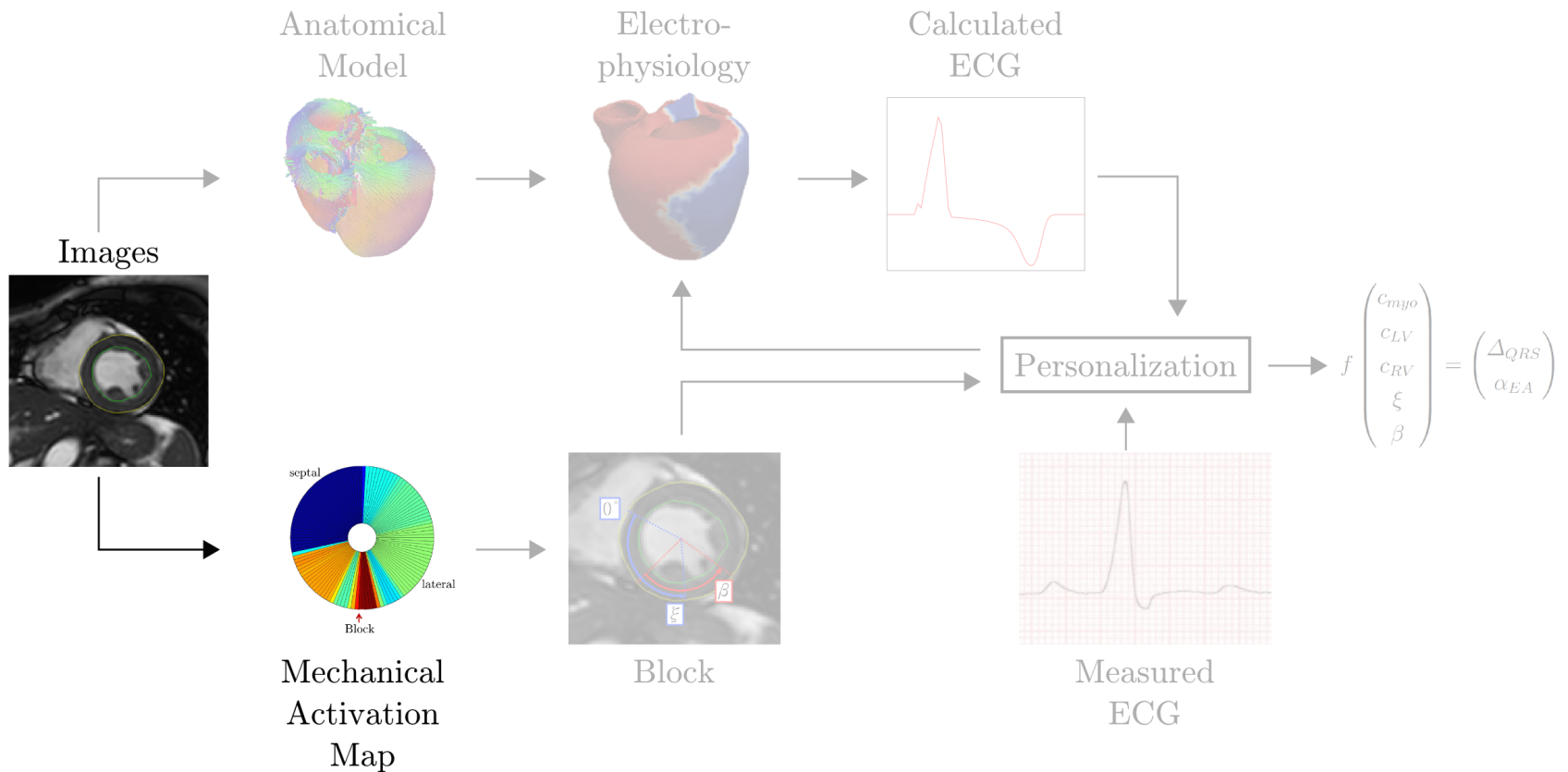



Strain Computation

- Aim: detecting myocardial contraction
- Lagrangian Strain Tensor:

$$E = \frac{1}{2} (\nabla \Phi_i + \nabla \Phi_i^T + \nabla \Phi_i \nabla \Phi_i^T) \quad (1)$$

- Principal strain (first eigenvalue of E)
⇒ Temporally resolved map of myocardial strain

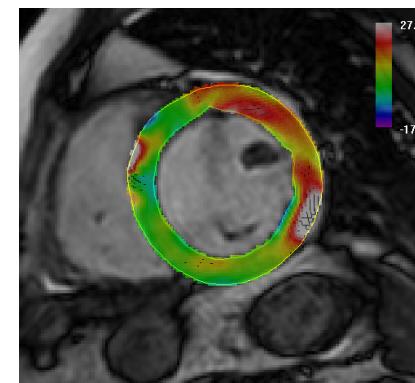
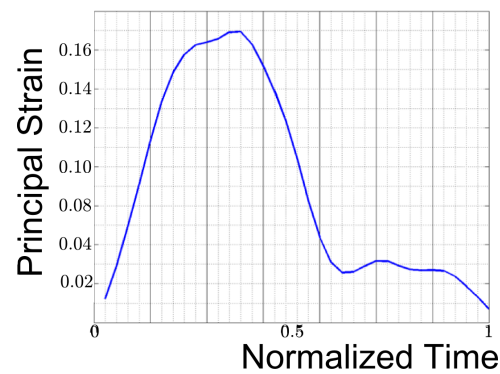

Strain Map at End-Systole



Block Detection from Mechanical Activation Maps

- Division of left ventricle into 120 segments (in short axis plane)
- Averaging
- Maximal contraction (peak of strain) indicates mechanical activation time
→ Polar map of mechanical activation
- U-shaped contraction pattern
→ Block at the latest activated segment

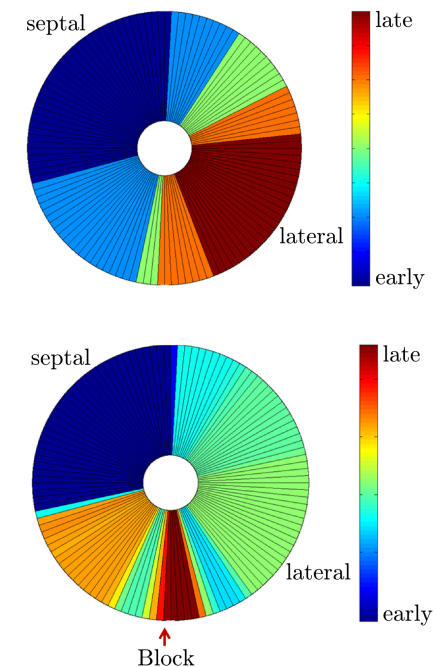

Electrophysiology Modeling



FRIEDRICH-ALEXANDER
UNIVERSITÄT
ERLANGEN-NÜRNBERG

TECHNISCHE FAKULTÄT



Workflow

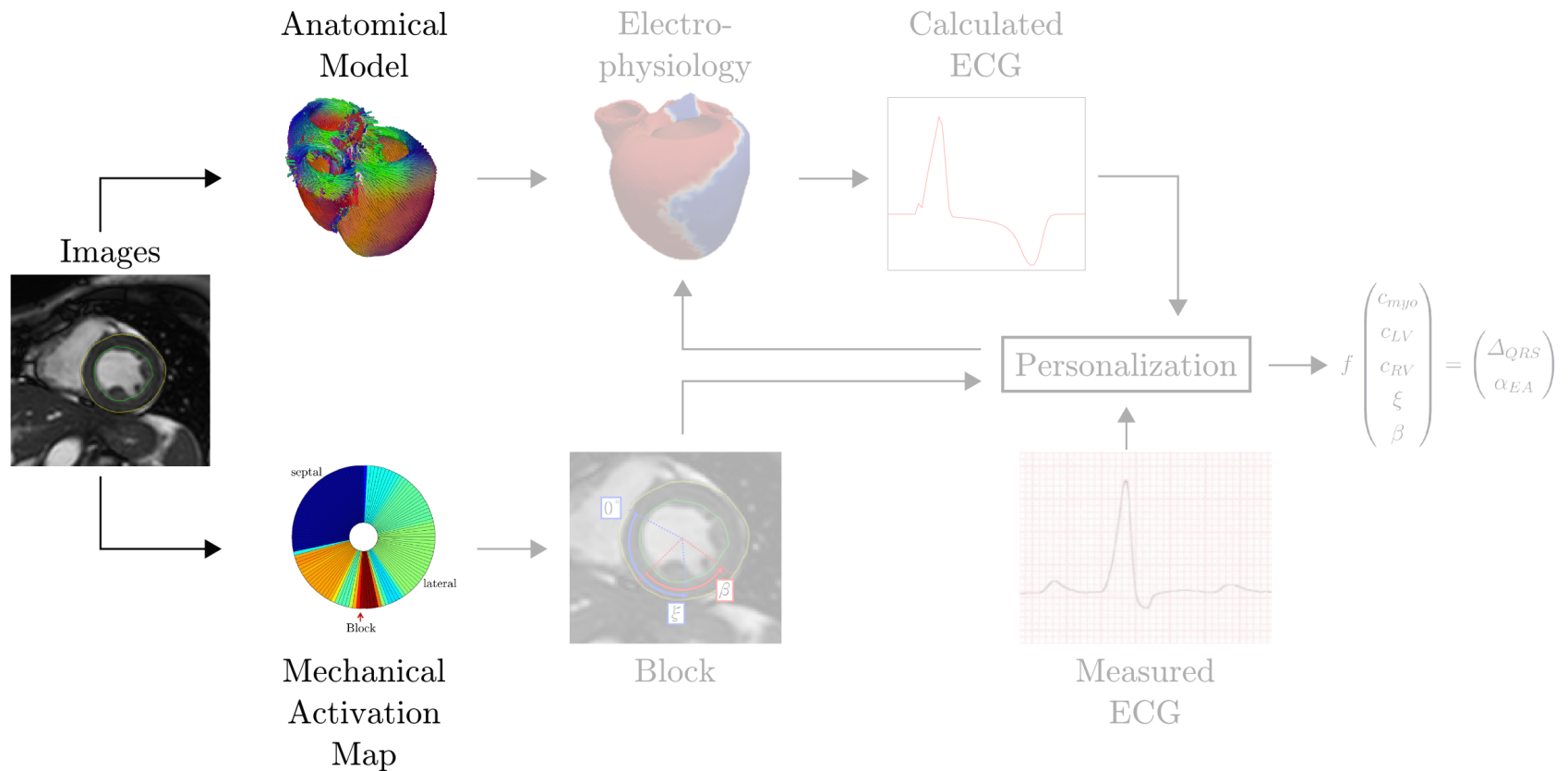



Anatomical Model

- Semi-automatic heart segmentation [Zheng et al., 2008]
- Tetrahedral finite element model
- Three domains for electrophysiology:
 - Myocardium (C_{myo})
 - Left-ventricular endocardium (C_{LV})
 - Right-ventricular endocardium (C_{RV})
- Fiber architecture for anisotropy
- Torso registration for ECG calculation

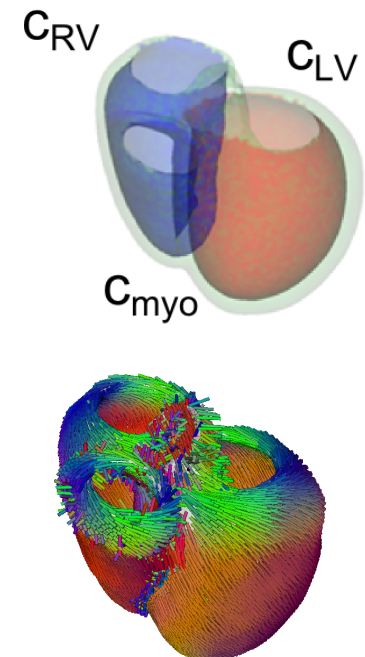



Workflow

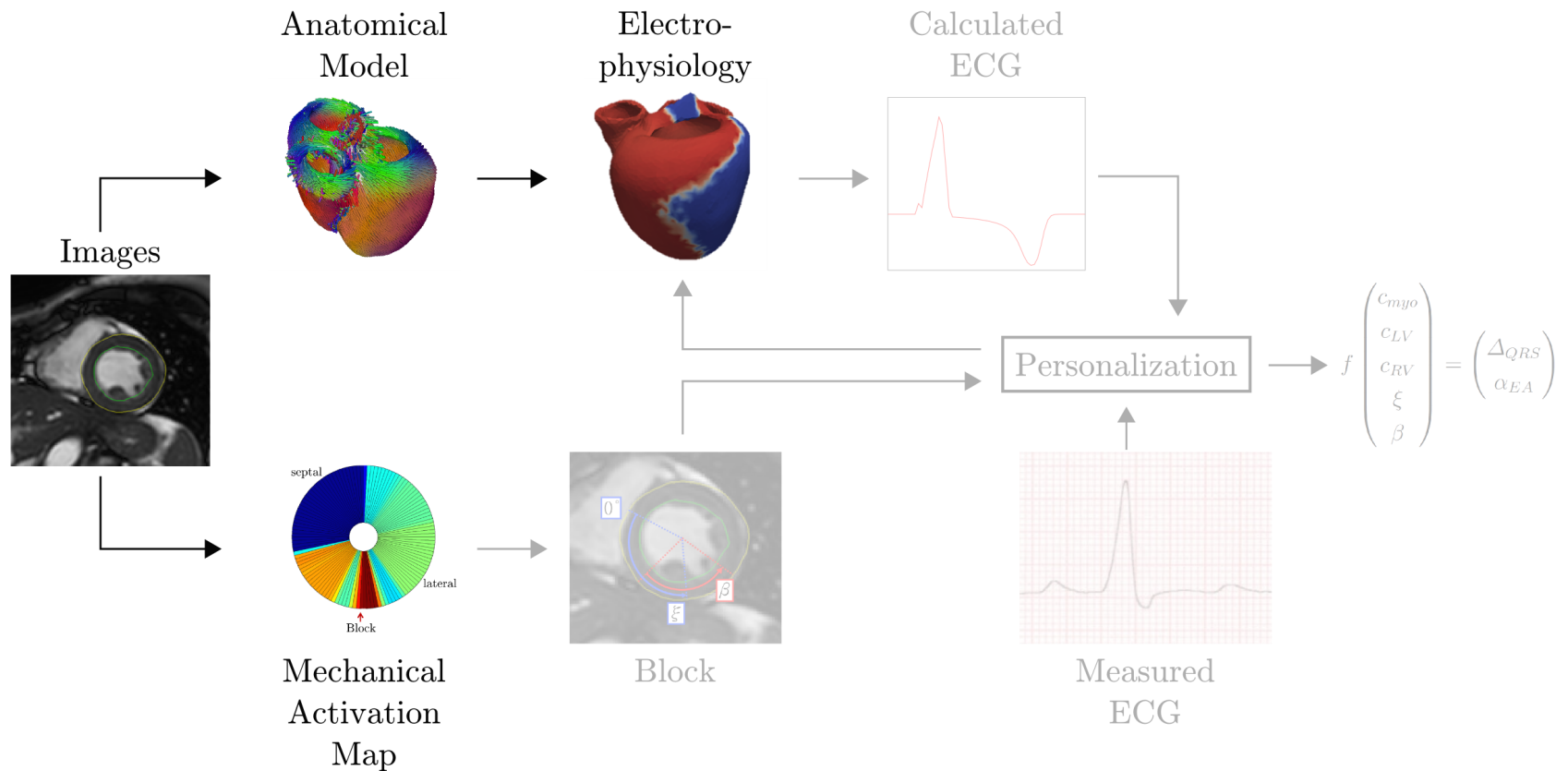



Action Potential

- Mitchell-Schaeffer model [Mitchell et al., 2003]
- Potentials $v(t)$ according to:

$$\frac{\partial v}{\partial t} = I_{in} + I_{out} + I_{stim} + c \nabla \cdot D \nabla v \quad (2)$$

- Parameters:
 - Transmembrane currents I_{in} and I_{out} : voltage in- and decrease
 - Stimulation current I_{stim}
 - Diffusion tensor D : anisotropy
- Crucial parameter: **electrical diffusion c** → Propagation of electrical wave
⇒ Low diffusion in the myocardium, high diffusion in the endocardia
(simulation of Purkinje system)

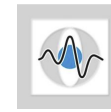

Workflow

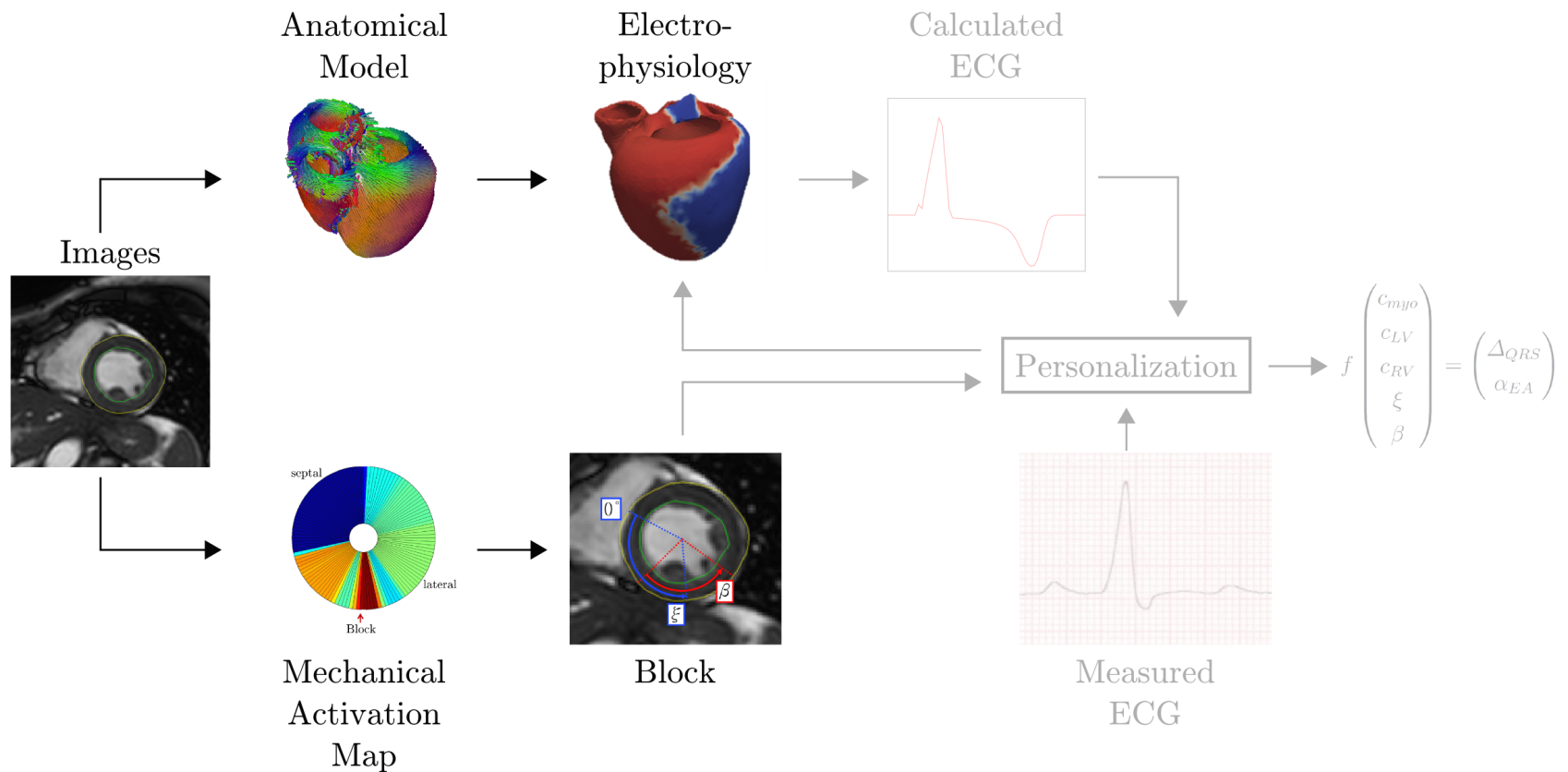



Incorporation of Block

- Block: new domain in the electrophysiology model
- Determined by:
 - Block angle β
 - Block position ξ
- Block centered around ξ
- Diffusion value $C_{Block} = C_{myo}$
(wave propagates over myocytes)
- Purpose: regional deceleration of electrical wave
⇒ U-shaped propagation pattern

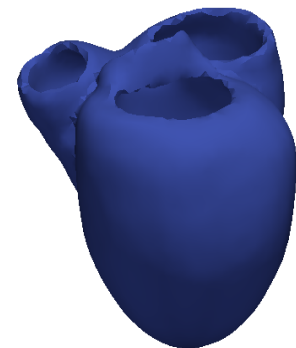
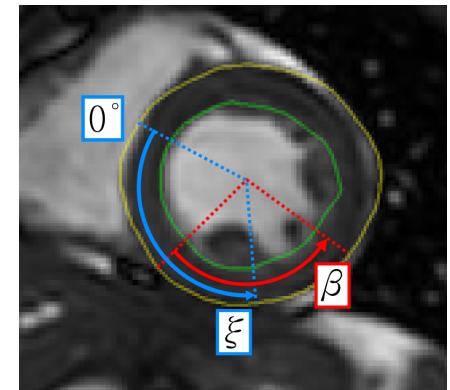



Workflow

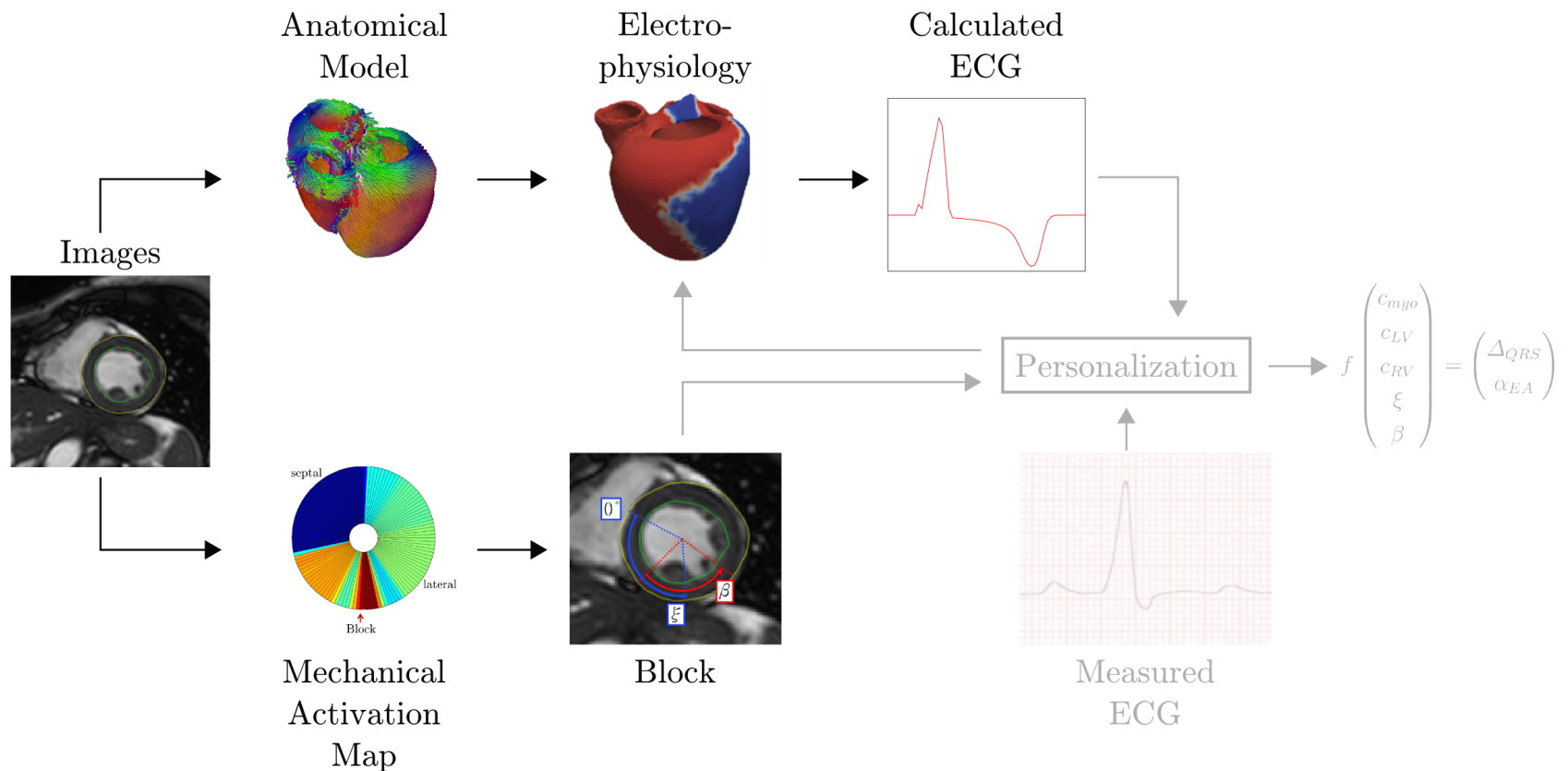



ECG Calculation

- Clinically measured 12-lead ECG is used for personalization
- Transformation of heart potentials to torso
- 12-lead ECG calculation
- Features from measured and calculated ECG: QRS duration Δ_{QRS} and electrical axis angle α_{EA}



QRS Duration

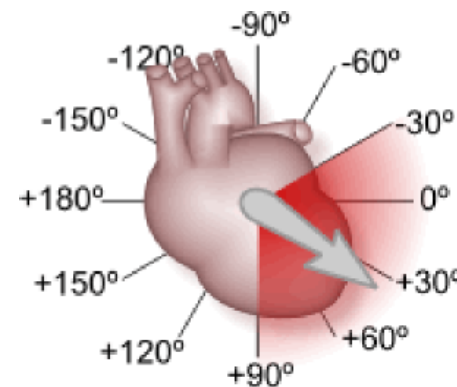

Electrical Axis



Workflow

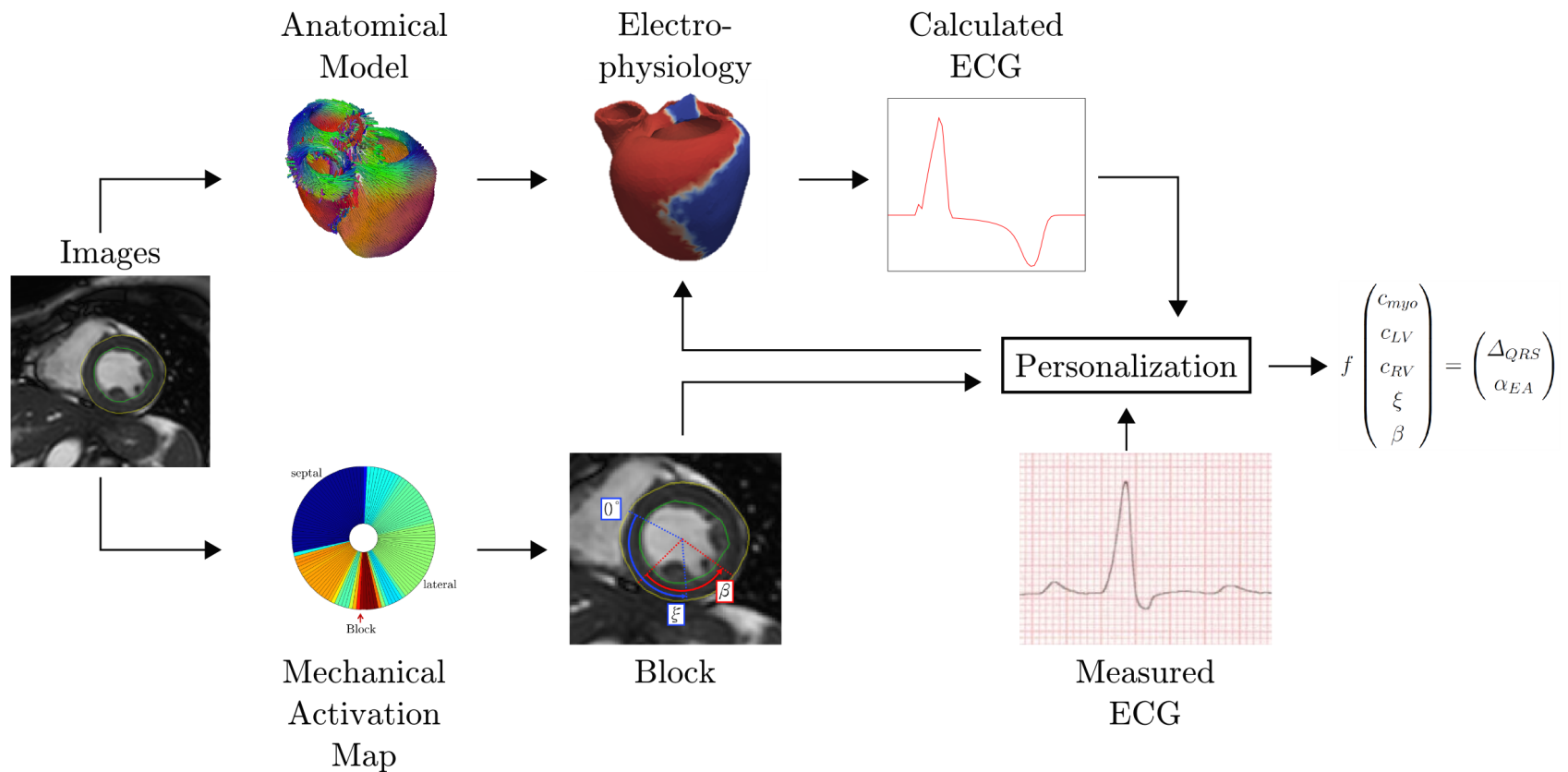

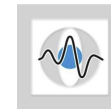

Model Personalization

- Optimization using a gradient-free estimation framework (BOBYQA) [Powell 2009]
- Personalization of:
 - Diffusion parameters c_{myo} , c_{LV} , c_{RV}
 - Block parameters β , ξ
- Block location ξ from mechanical activation maps (adjusted to cope with spatial inaccuracies)

$$\text{Model: } f(c_{myo}, c_{LV}, c_{RV}, \xi, \beta) = \begin{pmatrix} \Delta_{QRS} \\ \alpha_{EA} \end{pmatrix} \quad (3)$$

$$\text{Optimization: } \arg \min_{c_{myo}, c_{LV}, c_{RV}, \xi, \beta} \left| f - \begin{pmatrix} \Delta_{QRS, meas} \\ \alpha_{EA, meas} \end{pmatrix} \right| \quad (4)$$

Evaluation



FRIEDRICH-ALEXANDER
UNIVERSITÄT
ERLANGEN-NÜRNBERG

TECHNISCHE FAKULTÄT



Investigated Data

- 47 pathological datasets (University Hospital Heidelberg)
 - 12-lead ECG
 - Cine MRI
- Estimated mechanical activation maps on all cases
- U-shape pattern for 14 cases
- Evaluation of personalization on these 14 cases

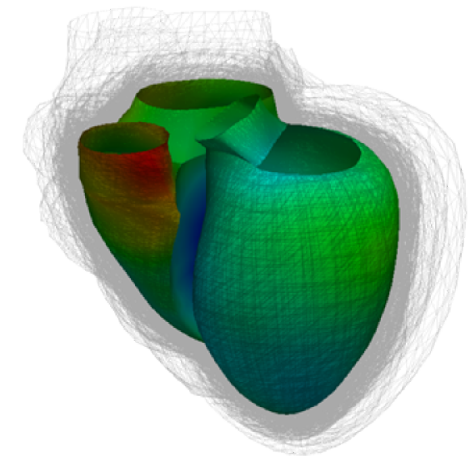



Sensitivity Analysis

- One representative patient set
- Investigated parameters:
 - Diffusion values
 - Action potential duration
 - Fiber angles
 - Resolution of mechanical activation maps
 - Block parameters
- ⇒ Justification of simplifications
- ⇒ Justification of personalization
- ⇒ Reasonable diffusion values



Sensitivity Analysis – Example

Myocardium Diffusivity

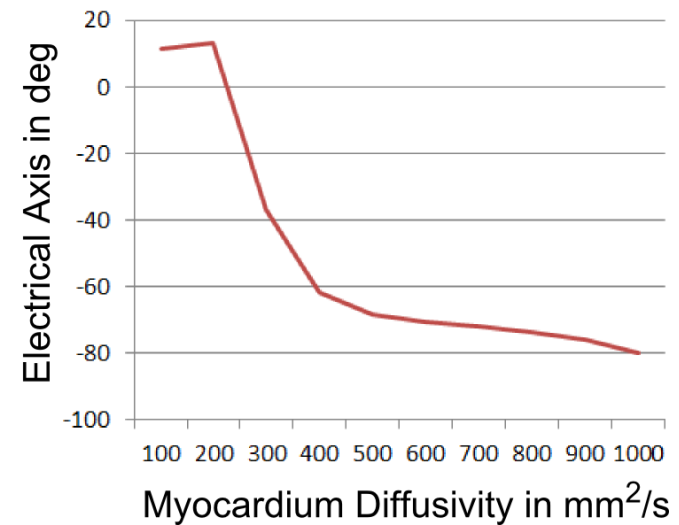
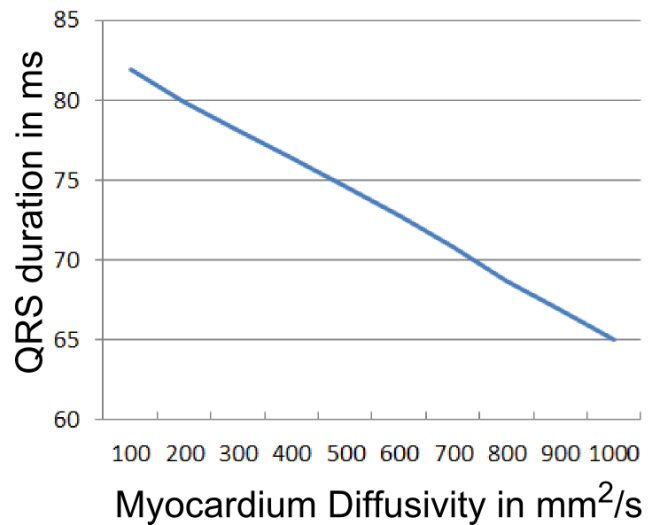

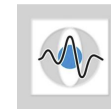

Sensitivity Analysis – Examples

Block Extent

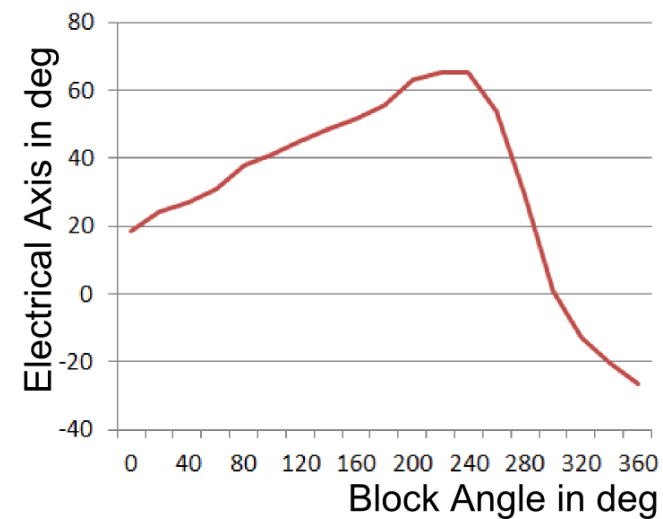
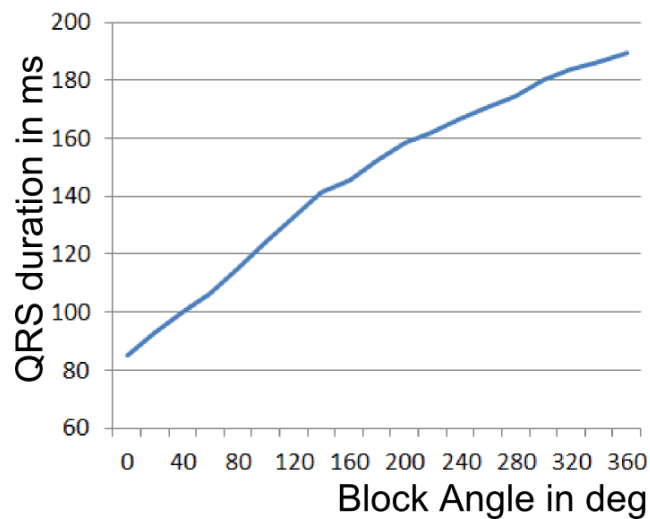

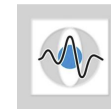

Quantitative Evaluation

- Acceptance criteria:
 - $\varepsilon_{QRS} = |\Delta_{QRS,meas} - \Delta_{QRS}| \leq 20 \text{ ms}$
 - $\varepsilon_{EA} = |\alpha_{EA,meas} - \alpha_{EA}| \leq 30^\circ$
- Comparison to personalization method with global diffusion values
- Improvements in average errors:
 - $\bar{\varepsilon}_{QRS,global} = 15 \text{ ms} \rightarrow \bar{\varepsilon}_{QRS,regional} = 1 \text{ ms}$
 - $\bar{\varepsilon}_{EA,global} = 42^\circ \rightarrow \bar{\varepsilon}_{EA,regional} = 18^\circ$
- Improvement in number of matched cases:
 - QRS duration: $n_{QRS,global} = 11 \rightarrow n_{QRS,regional} = 14$
 - Electrical axis: $n_{EA,global} = 7 \rightarrow n_{EA,regional} = 10$
 - Both features: $n_{global} = 5 \rightarrow n_{regional} = 10$



Quantitative Evaluation (cont.)

Patient	Δ_{QRS} (ms)			α_{EA} (°)		
	Measured	Regional	Global	Measured	Regional	Global
0006	146	146	135	-99	-106	-99
0009	174	174	189	-3	-3	-35
0010	170	184	203	-40	-40	-60
3519	89	88	101	112	115	-102
3577	122	122	123	-15	20	-15
3972	98	98	109	32	-40	-48
4446	90	90	95	-12	31	-12
4845	96	96	105	57	57	18
7874	166	163	137	90	89	-47
7957	124	124	123	-17	42	-7
8214	117	117	74	21	-7	21
8561	83	83	93	45	45	-32
8889	148	148	157	60	60	16
9583	130	130	149	-12	-12	-19

Conclusion and Outlook



FRIEDRICH-ALEXANDER
UNIVERSITÄT
ERLANGEN-NÜRNBERG

TECHNISCHE FAKULTÄT

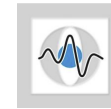

Conclusion

- Personalized computational electrophysiology models:
 - Better patient selection
 - Better therapy planning
- Current personalization methods based on **rarely available** or **global** data
- Our approach: **regional personalization** based on:
 - 12-lead ECG
 - Cine MRI

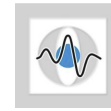

Conclusion (cont.)

- Basic components:
 - Motion information by image registration
 - Regional manipulation by block region
- Data:
 - Non-invasive acquisition
 - Wide availability
- Significant improvement compared to standard global method



Future Work

- Further regionality (right ventricle, inferior blocks)
- Exploitation of additional motion parameters or ECG features
- Evaluation on a larger database
- Investigation of predictive power
→ Simulated therapies

Thank you for your attention!



**FRIEDRICH-ALEXANDER
UNIVERSITÄT
ERLANGEN-NÜRNBERG**

TECHNISCHE FAKULTÄT