

# Multi-Resolution Analysis

Wavelets: CWT, DWT, Wavelet Series



**Dr. Elli Angelopoulou**

**Lehrstuhl für Mustererkennung (Informatik 5)**

**Friedrich-Alexander-Universität Erlangen-Nürnberg**



# Pattern Recognition Pipeline

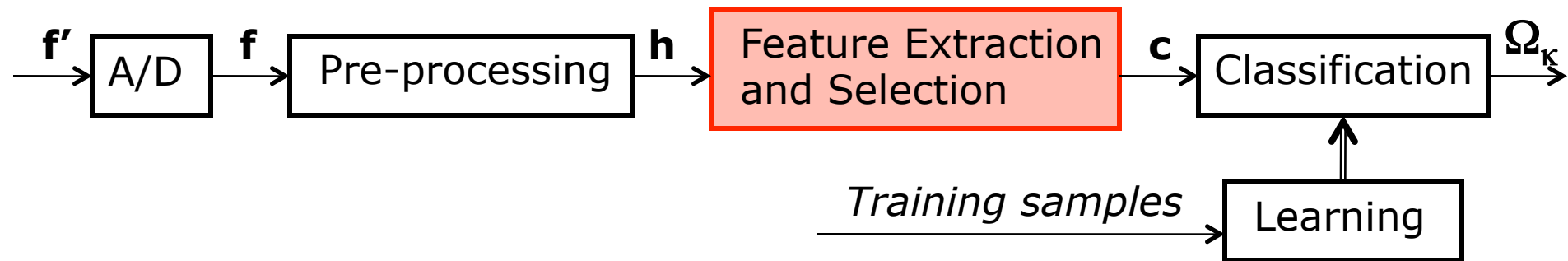

## ■ Heuristic feature extraction methods

- Projection to new orthogonal basis
- Linear Predictive Coding (LPC)
- Geometric Moments
- **Wavelets**

## ■ Analytic feature extraction methods

## ■ Feature selection



# Simple Low-pass Filter

- Let  $\vec{f} = (\dots, \vec{f}_7, \vec{f}_0, \vec{f}_1, \vec{f}_2, \vec{f}_3, \vec{f}_4, \vec{f}_5, \vec{f}_6, \vec{f}_7, \vec{f}_0, \vec{f}_1, \dots)$  be a periodic signal.
- A simple low-pass filter can be:  $\vec{f}_i = \frac{1}{2}(\vec{f}_i + \vec{f}_{i-1})$
- The low-pass filtering can be written in a matrix form:

$$\begin{bmatrix} \vec{f}_0 \\ \vec{f}_1 \\ \vec{f}_2 \\ \vec{f}_3 \\ \vec{f}_4 \\ \vec{f}_5 \\ \vec{f}_6 \\ \vec{f}_7 \end{bmatrix} = \frac{1}{2} \begin{bmatrix} 1 & 0 & 0 & 0 & 0 & 0 & 0 & 1 \\ 1 & 1 & 0 & 0 & 0 & 0 & 0 & 0 \\ 0 & 1 & 1 & 0 & 0 & 0 & 0 & 0 \\ 0 & 0 & 1 & 1 & 0 & 0 & 0 & 0 \\ 0 & 0 & 0 & 1 & 1 & 0 & 0 & 0 \\ 0 & 0 & 0 & 0 & 1 & 1 & 0 & 0 \\ 0 & 0 & 0 & 0 & 0 & 1 & 1 & 0 \\ 0 & 0 & 0 & 0 & 0 & 0 & 1 & 1 \end{bmatrix} \begin{bmatrix} \vec{f}_0 \\ \vec{f}_1 \\ \vec{f}_2 \\ \vec{f}_3 \\ \vec{f}_4 \\ \vec{f}_5 \\ \vec{f}_6 \\ \vec{f}_7 \end{bmatrix}$$

Rank deficient!!



# Simple High-pass Filter

- Let  $\vec{f} = (\dots, \vec{f}_7, \vec{f}_0, \vec{f}_1, \vec{f}_2, \vec{f}_3, \vec{f}_4, \vec{f}_5, \vec{f}_6, \vec{f}_7, \vec{f}_0, \vec{f}_1, \dots)$  be a periodic signal.
- A simple high-pass filter can be:  $\vec{f}_i = \frac{1}{2}(\vec{f}_i - \vec{f}_{i-1})$
- The high-pass filtering can be written in matrix form:

$$\begin{bmatrix} \vec{f}_0 \\ \vec{f}_1 \\ \vec{f}_2 \\ \vec{f}_3 \\ \vec{f}_4 \\ \vec{f}_5 \\ \vec{f}_6 \\ \vec{f}_7 \end{bmatrix} = \frac{1}{2} \begin{bmatrix} 1 & 0 & 0 & 0 & 0 & 0 & 0 & -1 \\ -1 & 1 & 0 & 0 & 0 & 0 & 0 & 0 \\ 0 & -1 & 1 & 0 & 0 & 0 & 0 & 0 \\ 0 & 0 & -1 & 1 & 0 & 0 & 0 & 0 \\ 0 & 0 & 0 & -1 & 1 & 0 & 0 & 0 \\ 0 & 0 & 0 & 0 & -1 & 1 & 0 & 0 \\ 0 & 0 & 0 & 0 & 0 & -1 & 1 & 0 \\ 0 & 0 & 0 & 0 & 0 & 0 & -1 & 1 \end{bmatrix} \begin{bmatrix} \vec{f}_0 \\ \vec{f}_1 \\ \vec{f}_2 \\ \vec{f}_3 \\ \vec{f}_4 \\ \vec{f}_5 \\ \vec{f}_6 \\ \vec{f}_7 \end{bmatrix}$$

Rank deficient!!



# Downsampling

- Let  $N$  be even, then the downsampling operator

$$D: \mathbb{C}^N \rightarrow \mathbb{C}^{N/2}$$

is defined as:

$$D: (\vec{f}_0, \vec{f}_1, \dots, \vec{f}_{N-1}) \rightarrow (\vec{f}_0, \vec{f}_2, \dots, \vec{f}_{N-2})$$

- Can we compute the original signal from:
  - A downsampled low-pass filtered signal **and**
  - A downsampled high-pass filtered signal?



# Filtering and Downsampling

$$\vec{f} = \frac{1}{2} \begin{bmatrix} \vec{f}_0 + \vec{f}_7 \\ \vec{f}_1 + \vec{f}_0 \\ \vec{f}_2 + \vec{f}_1 \\ \vec{f}_3 + \vec{f}_2 \\ \vec{f}_4 + \vec{f}_3 \\ \vec{f}_5 + \vec{f}_4 \\ \vec{f}_6 + \vec{f}_5 \\ \vec{f}_7 + \vec{f}_6 \end{bmatrix} \quad D(\vec{f}) = \frac{1}{2} \begin{bmatrix} \vec{f}_0 + \vec{f}_7 \\ \vec{f}_2 + \vec{f}_1 \\ \vec{f}_4 + \vec{f}_3 \\ \vec{f}_6 + \vec{f}_5 \end{bmatrix}$$

$$\vec{h} = \frac{1}{2} \begin{bmatrix} \vec{f}_0 - \vec{f}_7 \\ \vec{f}_1 - \vec{f}_0 \\ \vec{f}_2 - \vec{f}_1 \\ \vec{f}_3 - \vec{f}_2 \\ \vec{f}_4 - \vec{f}_3 \\ \vec{f}_5 - \vec{f}_4 \\ \vec{f}_6 - \vec{f}_5 \\ \vec{f}_7 - \vec{f}_6 \end{bmatrix} \quad D(\vec{h}) = \frac{1}{2} \begin{bmatrix} \vec{f}_0 - \vec{f}_7 \\ \vec{f}_2 - \vec{f}_1 \\ \vec{f}_4 - \vec{f}_3 \\ \vec{f}_6 - \vec{f}_5 \end{bmatrix}$$

$$D(\vec{f}) + D(\vec{h}) = \begin{bmatrix} \vec{f}_0 \\ \vec{f}_2 \\ \vec{f}_4 \\ \vec{f}_6 \end{bmatrix}$$

$$D(\vec{f}) - D(\vec{h}) = \begin{bmatrix} \vec{f}_7 \\ \vec{f}_1 \\ \vec{f}_3 \\ \vec{f}_5 \end{bmatrix}$$

**=no info loss**

# A Multiresolution Analysis Scheme

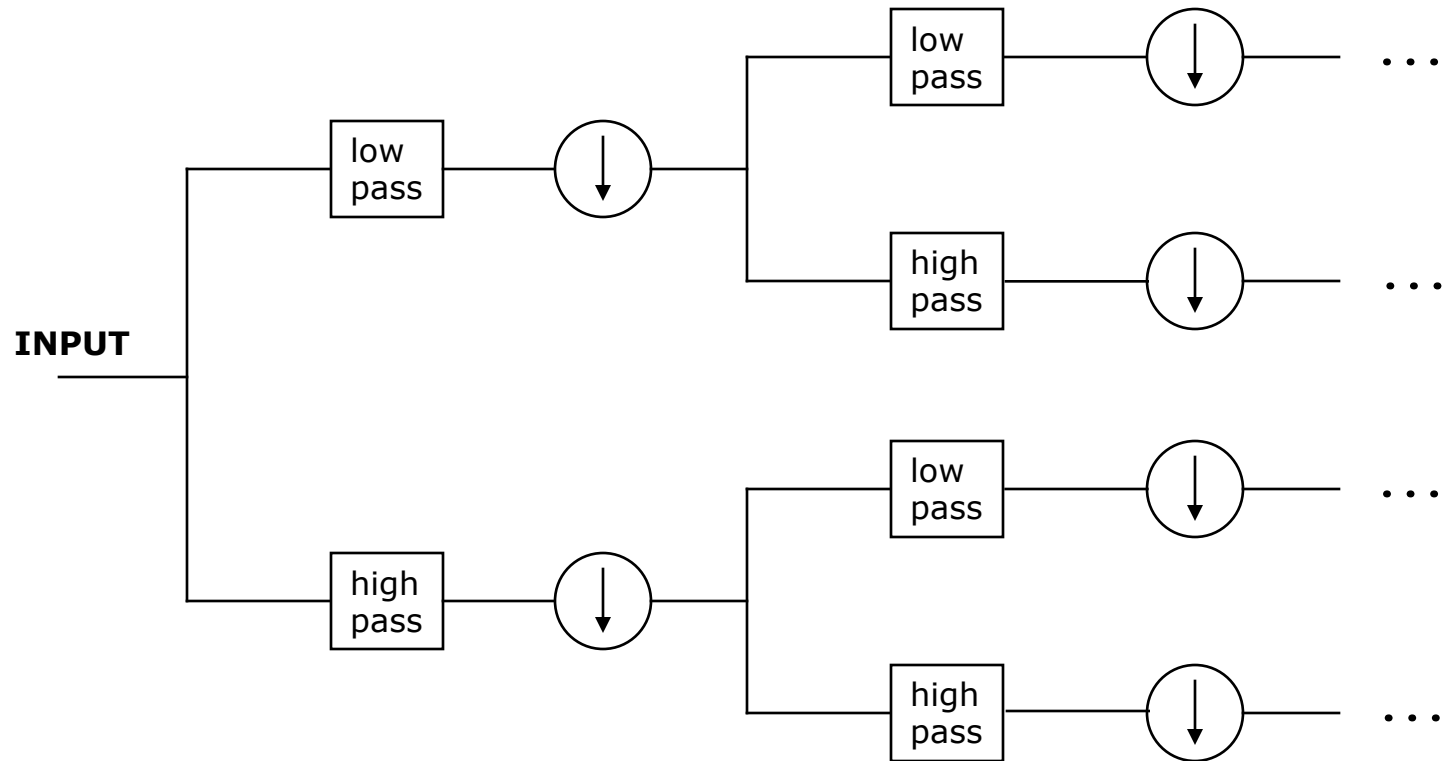



# Fourier-based Frequency Analysis

- Basis functions are sinusoids.
- If the signal is a sinusoid, then it is better described and localized in the frequency domain.

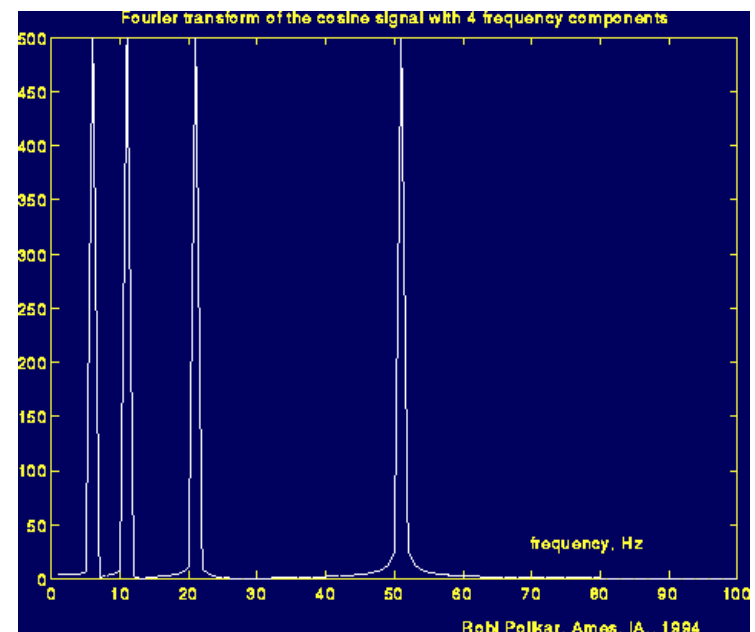
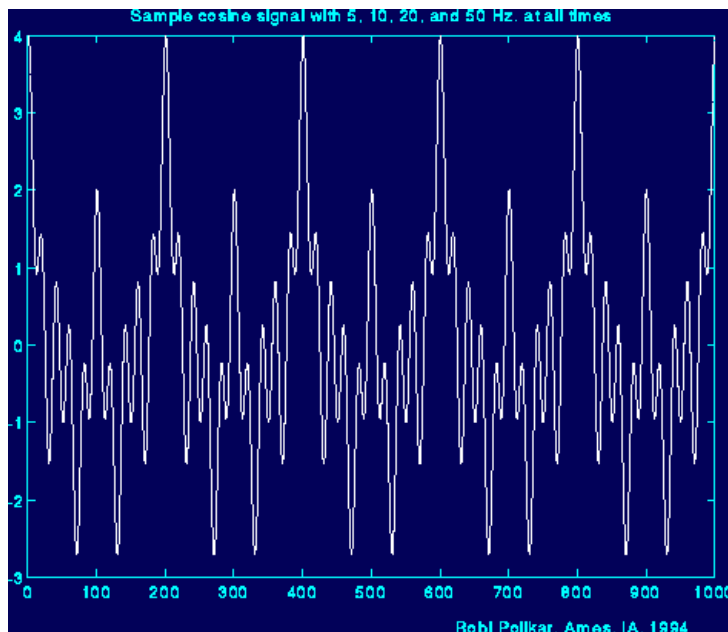

$$f(t) = \cos(2\pi 5t) + \cos(2\pi 10t) + \cos(2\pi 20t) + \cos(2\pi 50t)$$

$$F(t)$$



# Fourier Analysis – limitation 1



- Many coefficients are required to describe a discontinuous signal.
- If the signal is a sinusoid, it is better described in the frequency domain.
- If the signal is a square pulse it is better described in the time domain.

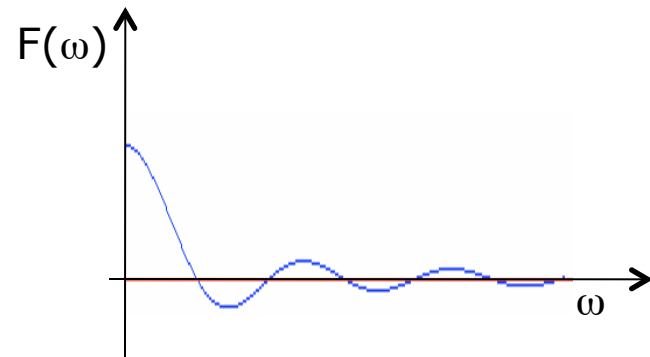
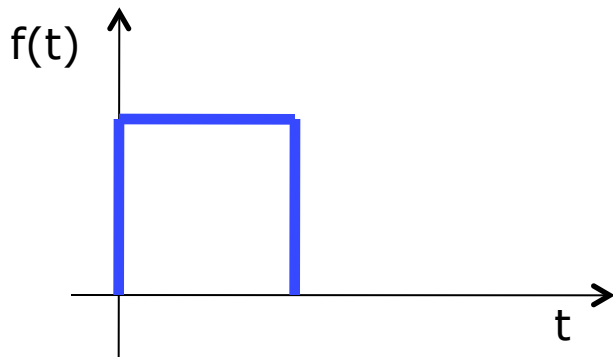



# Fourier Analysis – limitation 2

- The time content of the signal is lost.
- Distinct signals in the time domain can generate the same frequency response.

**Different in Time Domain**

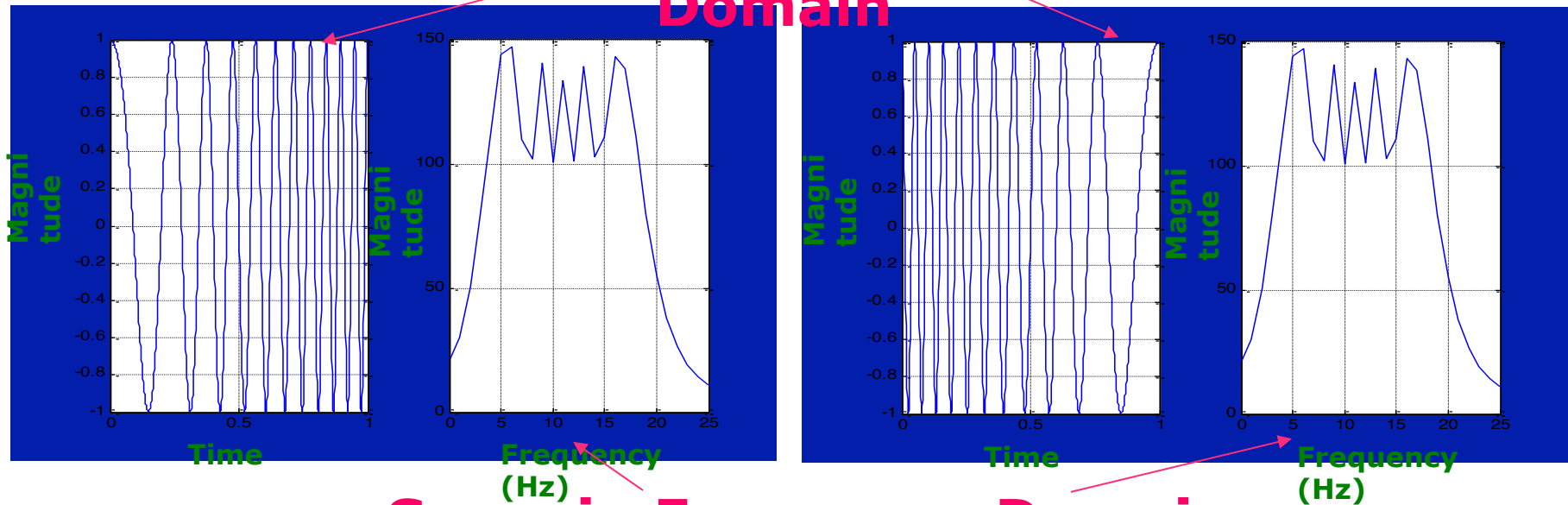

**Same in Frequency Domain**



# Solution: Short Time Fourier Transform

- Use windows to analyze a small section of the signal at a time  $\Rightarrow$  STFT.
- Fixed window size.
- Narrow window leads to poor frequency resolution.

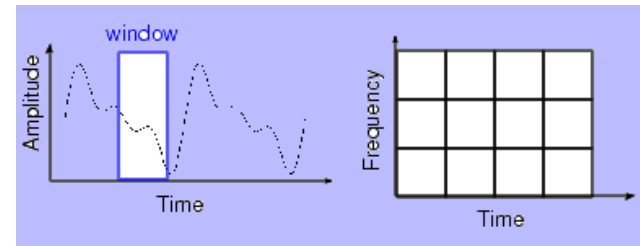
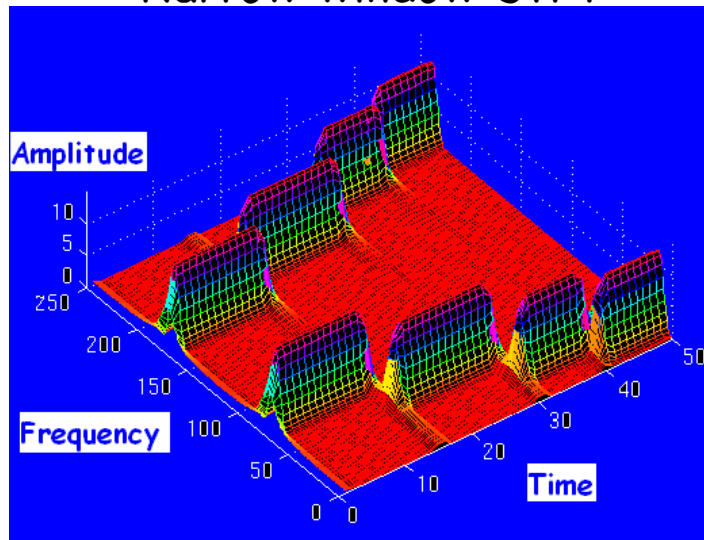

Image courtesy of Fengxiang Qiao

Narrow window STFT



- Peaks are well separated in time.
- Each peak in the frequency domain covers a range of frequencies, instead of a single frequency.



# Solution: Short Time Fourier Transform

- Fixed window size.
- Wide window leads to poor time resolution.

Wide window STFT

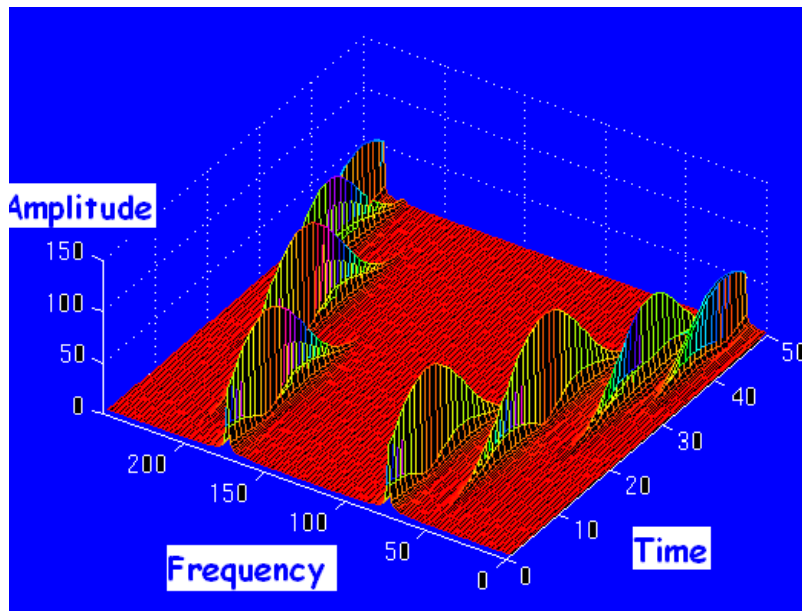

- Peaks are overlapping in time.
- Each peak in the frequency domain is very narrow, approaching a single frequency.



# Multi-Resolution Analysis (MRA)

- Idea: use different window sizes, i.e. varying resolution.
- Since we do not know ahead of time, which resolution should be used at what time instance, analyze the signal in multiple resolutions.
- In practice many signals exhibit high frequencies over short time durations and low frequencies over extended periods of time.
- MRA is designed to give
  - Good time- and poor frequency-resolution at high frequencies
  - Poor time- and good frequency-resolution at low frequencies.

# Wavelet



- A wavelet is a mathematical tool designed for multi-resolution analysis.
- It is used in dividing a given signal into different frequency components and analyzing each component with a resolution that matches its scale.
- It uses a sliding scalable window.
- The building block of the wavelet transform, its window, is a small wave, *a wavelet*, which is given by a function  $\psi(t)$ .
- A *wavelet transform* is the representation of a signal  $f(t)$  by wavelets.



# Continuous Wavelet Transform

- Like the STFT the signal is multiplied with a function.
- In STFT we have the windowing function and then take the FT.

$$\text{STFT}_f^w(\tau) = \int_{-\infty}^{\infty} f(t)w(t - \tau)e^{-j\omega t} dt$$

- In wavelet analysis the signal is multiplied with a function of varying resolution. The multiplicative function is a sinusoidal function called a *wavelet*.

$$\text{CWT}_f^\psi(\tau, \alpha) = \frac{1}{\sqrt{|\alpha|}} \int_{-\infty}^{\infty} f(t)\psi^*\left(\frac{t - \tau}{\alpha}\right) dt$$



# Continuous Wavelet Transform

- The multiplicative function  $\psi^*$  is the wavelet.

$$\text{CWT}_f^\psi(\tau, \alpha) = \frac{1}{\sqrt{|\alpha|}} \int_{-\infty}^{\infty} f(t) \psi^* \left( \frac{t - \tau}{\alpha} \right) dt$$

- $\tau$  is the location of the analyzed signal (where the wavelet is positioned)
- $\alpha$  is the scale (the resolution) of the wavelet.
- There exists a **mother wavelet**  $\psi$ , which is the prototype wavelet out of which all the children wavelets (the shifted and scaled versions) are created.





# Scale

- All the children wavelets are either **dilated or compressed and shifted** versions of the mother wavelet.
- Scale
  - $\alpha > 1$ : dilated wavelet
  - $\alpha < 1$ : compressed wavelet
- Low Frequency -> Large Scale -> Non-detailed global view of the signal -> Span the entire signal.
- High Frequency -> Small Scale -> Detailed view of the signal -> Lasts short time.
- Only a limited range of scales is necessary.



# Computing the CWT of a Signal

$$CWT_f^\psi(\tau, \alpha) = \frac{1}{\sqrt{|\alpha|}} \int f(t) \psi^* \left( \frac{t - \tau}{\alpha} \right) dt$$

1. Set  $\alpha=1$  and place the wavelet at the beginning of the signal.
2. The wavelet at scale "1" is multiplied with the signal, integrated over time and scaled by  $\frac{1}{\sqrt{|\alpha|}}$
3. Shift the wavelet at  $t=\tau$  and reevaluate step 2, at the new position, i.e. compute the transform at time  $\tau$  and scale  $\alpha$ . (During the 1<sup>st</sup> iteration  $\alpha=1$ .) Repeat until you reach the end of the signal.
4. Increase the scale  $\alpha$  by a small amount and repeat steps 2 and 3. Do so for multiple  $\alpha$  values.

# Illustration of 1<sup>st</sup> Pass

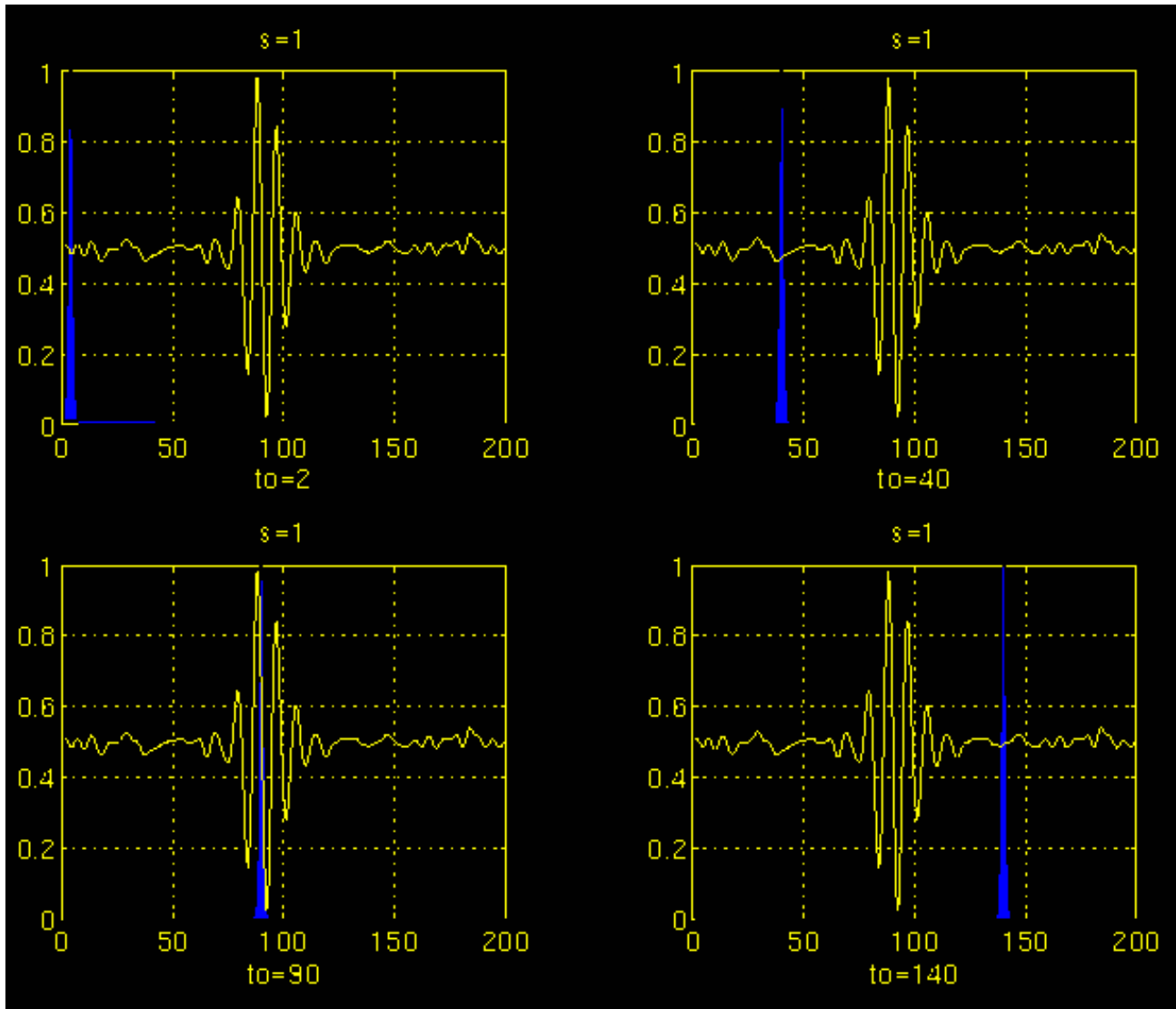

Image courtesy of Robi Polikar <http://users.rowan.edu/~polikar/WAVELETS/WTpart3.html>

# Illustration of Pass with Medium Scale

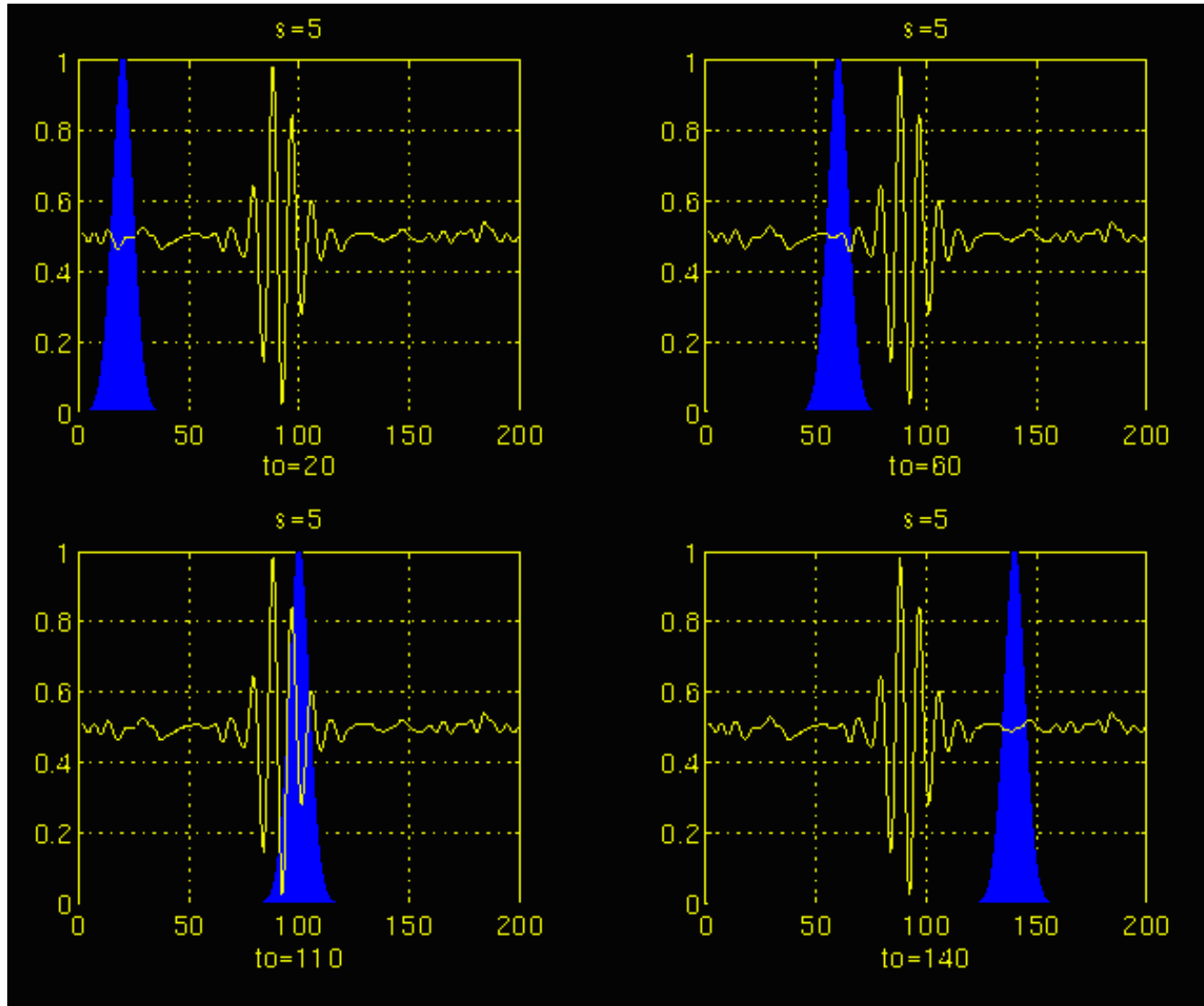

Image courtesy of Robi Polikar <http://users.rowan.edu/~polikar/WAVELETS/WTpart3.html>



# Illustration of Pass with Large Scale

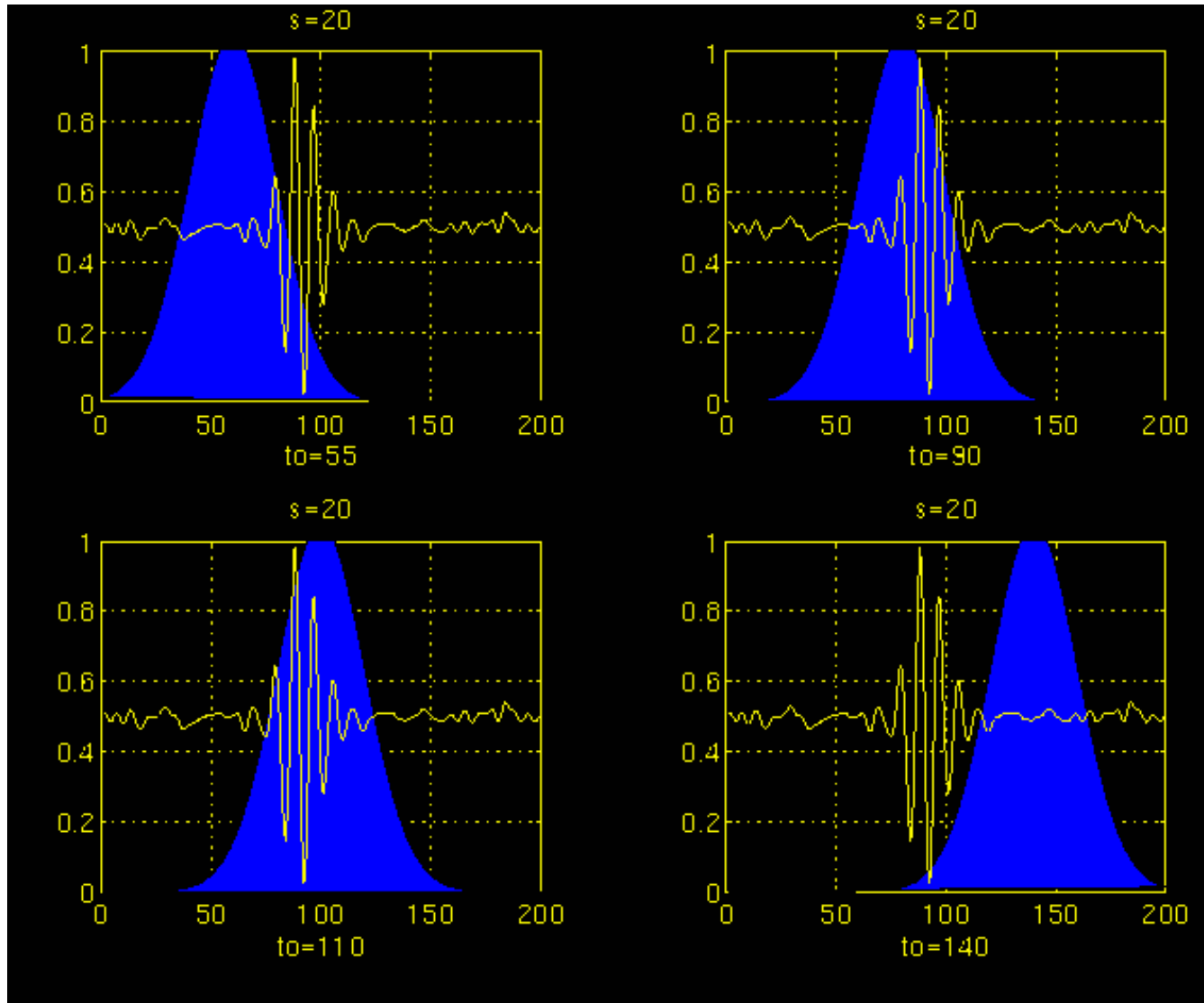
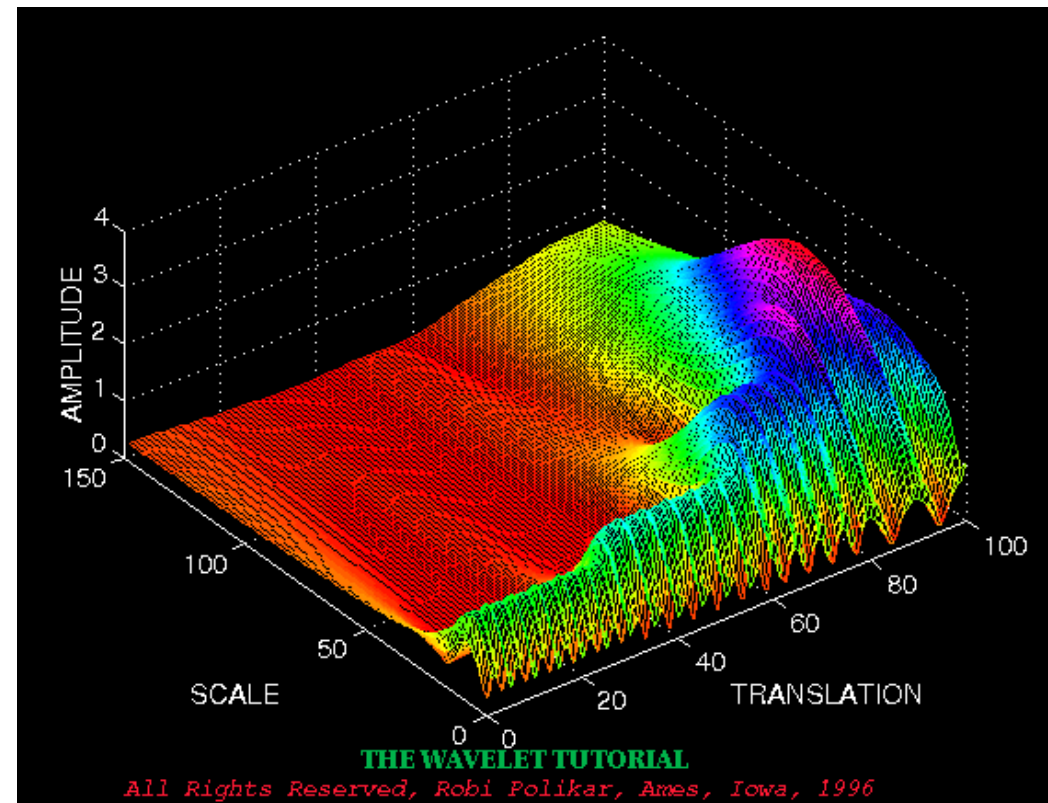
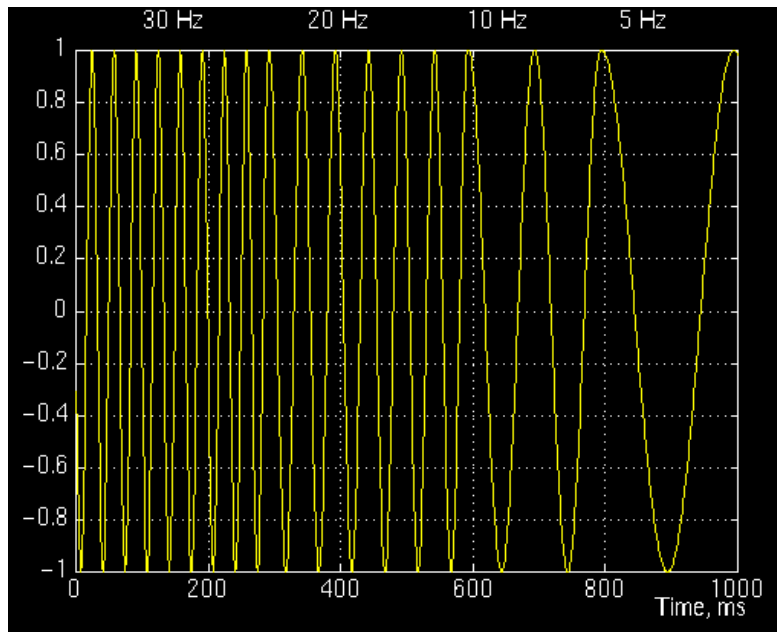
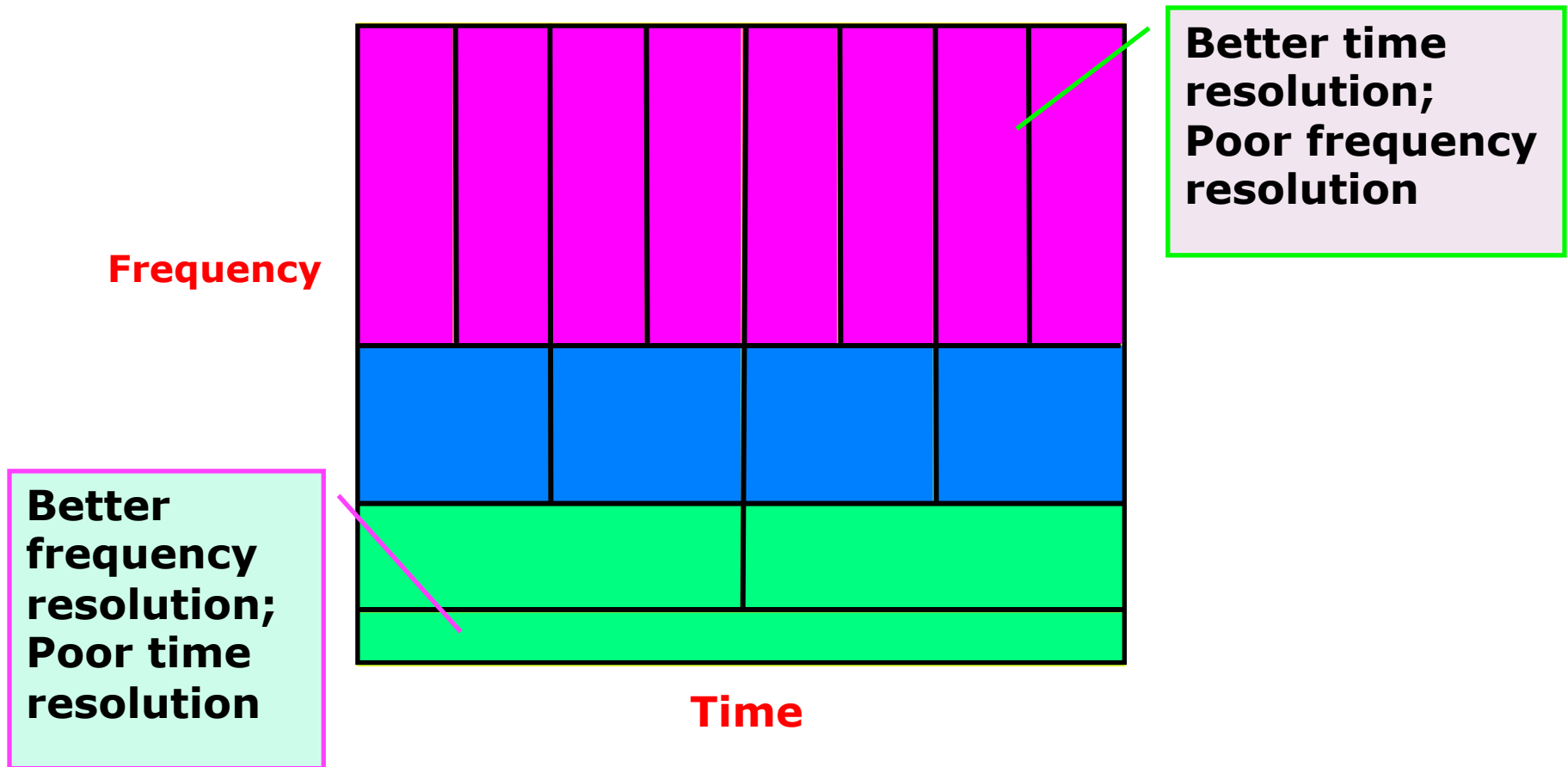

Image courtesy of Robi Polikar <http://users.rowan.edu/~polikar/WAVELETS/WTpart3.html>

# A Signal and its CWT



# Visualization of Wavelet MRA





# Comparison of Transformations

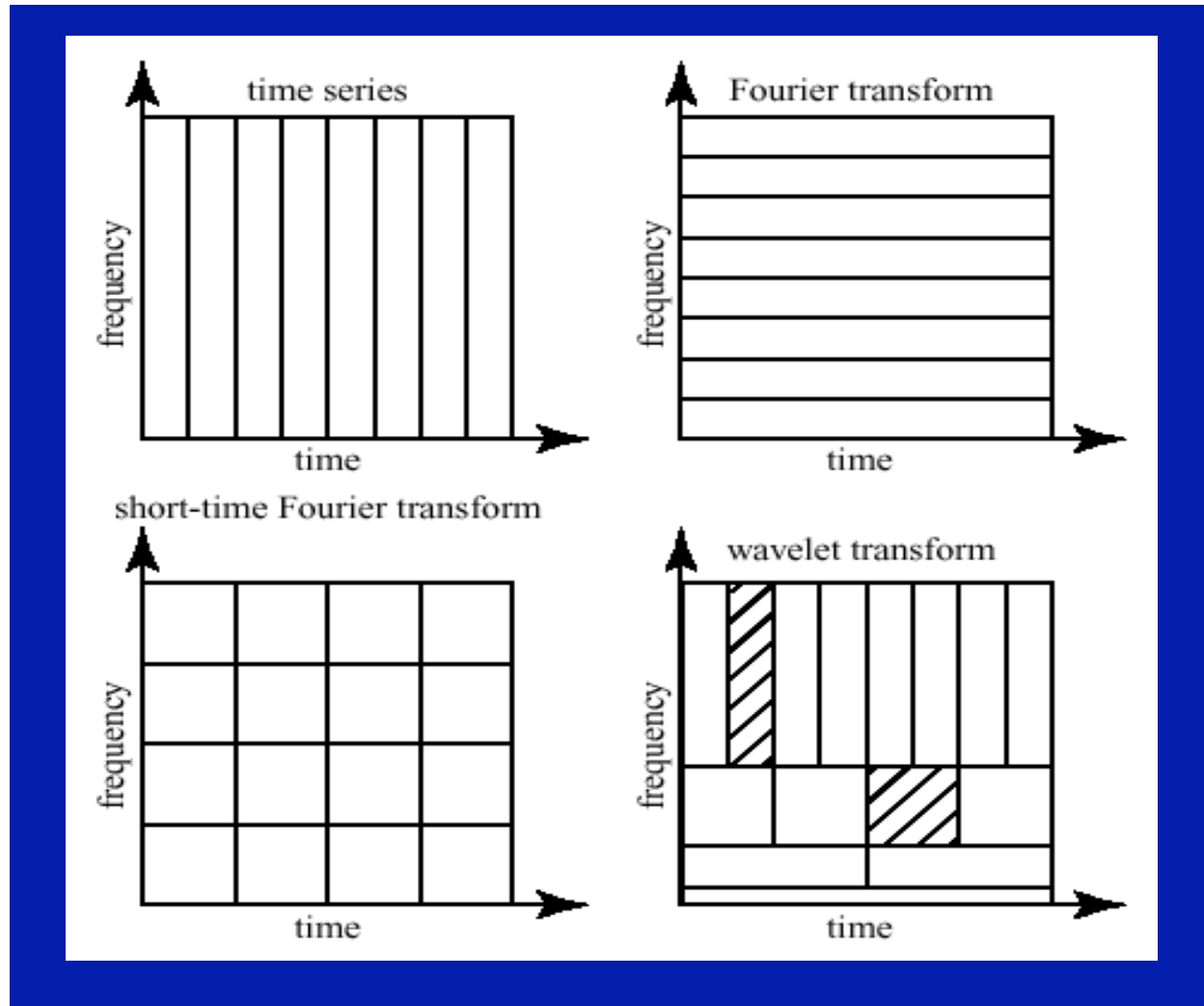

Figure courtesy of [http://www.cerm.unifi.it/EUcourse2001/Gunther\\_lecturenotes.pdf](http://www.cerm.unifi.it/EUcourse2001/Gunther_lecturenotes.pdf), p.10





# Reconstructing a signal from the CWT

- The original signal can be reconstructed with the inverse transform:

$$f(t) = \frac{1}{c_\psi} \int_{-\infty}^{\infty} \int_{-\infty}^{\infty} \frac{1}{\alpha^2} \text{CWT}_f^\psi(\tau, \alpha) \frac{1}{\sqrt{|\alpha|}} \psi^*\left(\frac{t-\tau}{\alpha}\right) dt d\alpha$$

- where  $c_\psi$  is the *admissibility constant* and is defined as:

$$c_\psi = \int_{-\infty}^{\infty} \frac{|\Psi(\omega)|^2}{|\omega|} d\omega$$

- and  $\Psi(\omega) = \text{FT}(\psi(t))$  .



# Wavelet function

- A wave signal can be used as a wavelet iff it satisfies the following conditions:

1. admissibility condition:  $0 < c_\psi < \infty$

2.  $\psi(t)$  is absolutely integrable:  $\int_{-\infty}^{\infty} |\psi(t)| dt < \infty$

3. and  $\psi(t)$  is square integrable:  $\int_{-\infty}^{\infty} |\psi(t)|^2 dt < \infty$

- Wavelets that satisfy the following 2 conditions, also satisfy the previous 3 conditions:

1.  $\psi(t)$  is a zero-mean function:  $\int_{-\infty}^{\infty} \psi(t) dt = 0$

2. and  $\psi(t)$  has a squared norm of one:  $\int_{-\infty}^{\infty} |\psi(t)|^2 dt = 1$



# Morlet Wavelet

- The Morlet wavelet is defined as:  $\psi(t) = e^{-\frac{t^2}{2\alpha}} e^{j\omega t}$   
where  $\omega$  controls the number of oscillations.

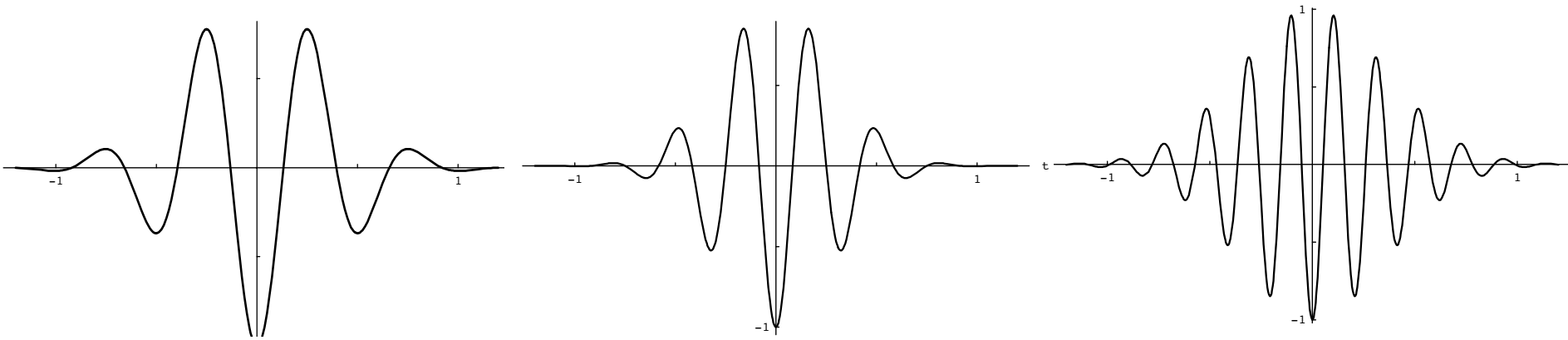

$$\alpha=3.8$$
$$\omega=2\pi 1.9$$

$$\alpha=6$$
$$\omega=2\pi 3.0$$

$$\alpha=3.8$$
$$\omega=2\pi 4.8$$

# Other Wavelets



- The Mexican Hat wavelet is

defined as: 
$$\psi(t) = \left(1 - \frac{t^2}{\alpha^2}\right) e^{-\frac{t^2}{2\alpha^2}}$$

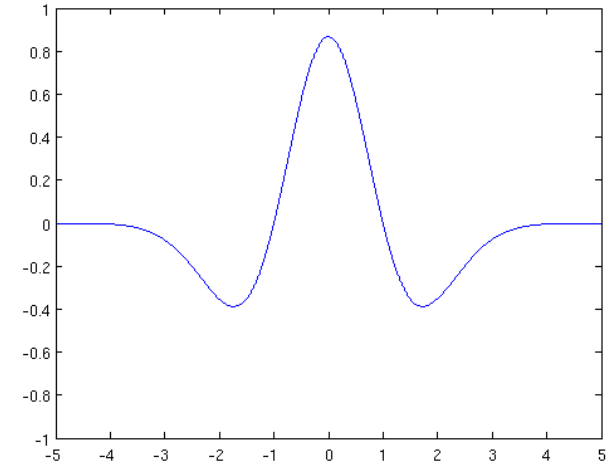

Image courtesy of <http://commons.wikipedia.org>

- The Shannon wavelet is

defined as: 
$$\psi(t) = \sqrt{\alpha} \text{sinc}(\alpha t) e^{j\omega t}$$

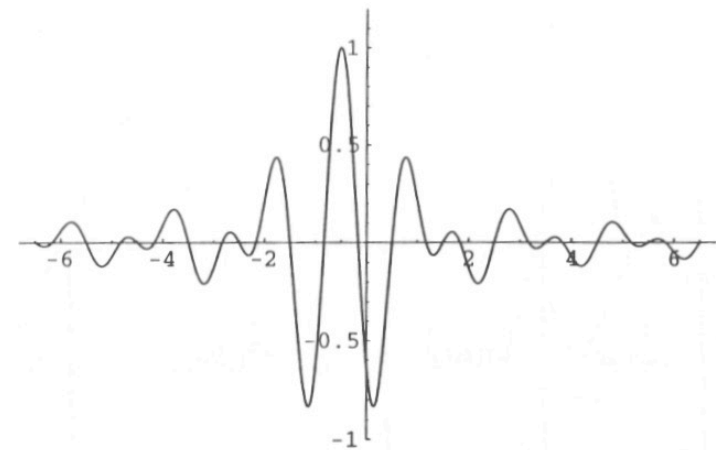

Image courtesy of <http://commons.wikipedia.org>



# Haar Wavelet

- The Haar wavelet is a single square wave defined as:

$$\psi(t) = \begin{cases} 1 & \text{for } 0 \leq t < \frac{1}{2} \\ -1 & \text{for } \frac{1}{2} \leq t < 1 \\ 0 & \text{otherwise} \end{cases}$$

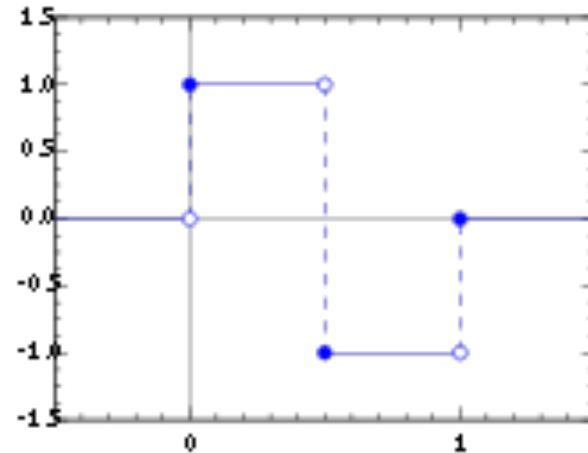

Image courtesy of <http://commons.wikipedia.org>

- The children wavelets are then:  $\psi_{\alpha,\tau}(t) = 2^{\frac{\alpha}{2}} \psi(2^\alpha t - \tau)$   
 where the amplitude of the square wave is  $2^{\frac{\alpha}{2}}$   
 the width of the square wave is  $2^{-\alpha}$   
 and the position of the square wave is  $\tau 2^{-\alpha}$



# Drawbacks of CWT

- Infinite number of wavelets.
- High redundancy (regarding signal reconstruction).
- Often can not be computed analytically.
- Even if when we use a discretized version of CWT, computing the wavelet transform may take a couple of hours for large signals and high resolution of scale and translation.

(Although it can also only take a second for small signals and low resolution).

# Discrete Wavelet Transform (DWT)



- Idea 1: Use Nyquist sampling theory to eliminate redundancy with minimal information loss.
- Idea 2: Use the nice toolbox of filtering and convolution in performing wavelet analysis.
- A discrete wavelet transform is a wavelet transform where the wavelets can only be scaled and translated in discrete steps.
- The scaling and translation intervals are determined by sampling theory.

# CWT versus DWT



## ■ In CWT

- Change the scale of the analysis window (wavelet).
- Shift the window (wavelet) in time.
- Multiply with the signal.
- Integrate over time.

## ■ In DWT

- Use filters of different frequencies to analyze the signal at different scales
  - Because frequency cutoff filters come at limited range (i.e. high-pass and low-pass filters), frequency analysis at finer resolutions is achieved by changing the scale of the signal via subsampling (downsampling).
- Apply the filter (shift the filter-window, multiply and integrate)





# Continuous Wavelet Transform - review

- The multiplicative function  $\psi^*$  is the wavelet.

$$\text{CWT}_f^\psi(\tau, \alpha) = \frac{1}{\sqrt{|\alpha|}} \int_{-\infty}^{\infty} f(t) \psi^* \left( \frac{t - \tau}{\alpha} \right) dt$$

- $\tau$  is the location of the analyzed signal (where the wavelet is positioned)
- $\alpha$  is the scale (the resolution) of the wavelet.
- There exists a **mother wavelet**  $\psi$ , which is the prototype wavelet out of which all the children wavelets (the shifted and scaled versions) are created.



# Computation of the DWT

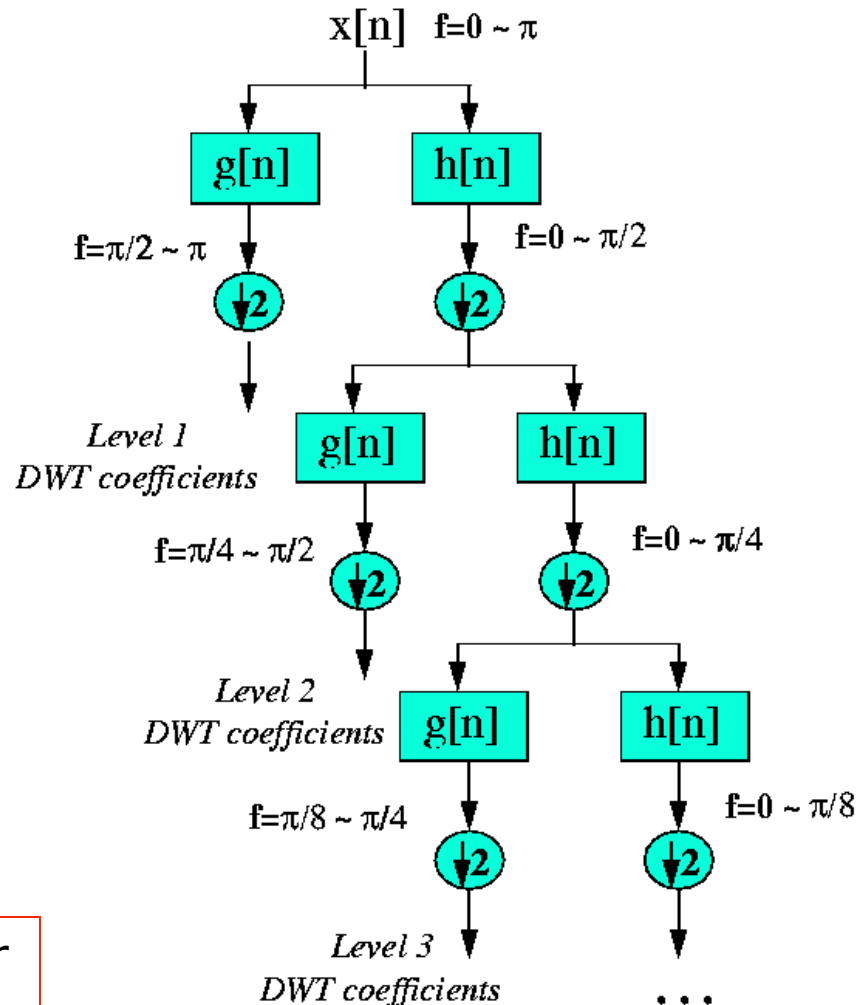

$g[n]$ : highpass filter  
 $h[n]$ : lowpass filter

where  $g[n]$  is a half-band highpass filter,  $h[n]$  is a half-band lowpass filter and  $x[n]$  is the input signal with frequency between 0 and  $\pi$ .



## Why subsample?

- Consider a half-band lowpass filter.
- It removes all the frequencies above half of the highest frequency in the signal.
- If the original highest frequency was 1200Hz, after half-band lowpassing, the highest frequency is 600Hz.
- According to Nyquist sampling rate,  $\Delta t = \frac{1}{2B_t}$ , since the highest frequency is halved, we can sample the signal at twice as big sampling intervals.
- We can store/analyze a downsampled by a factor of 2 sample without information loss.



# DWT example

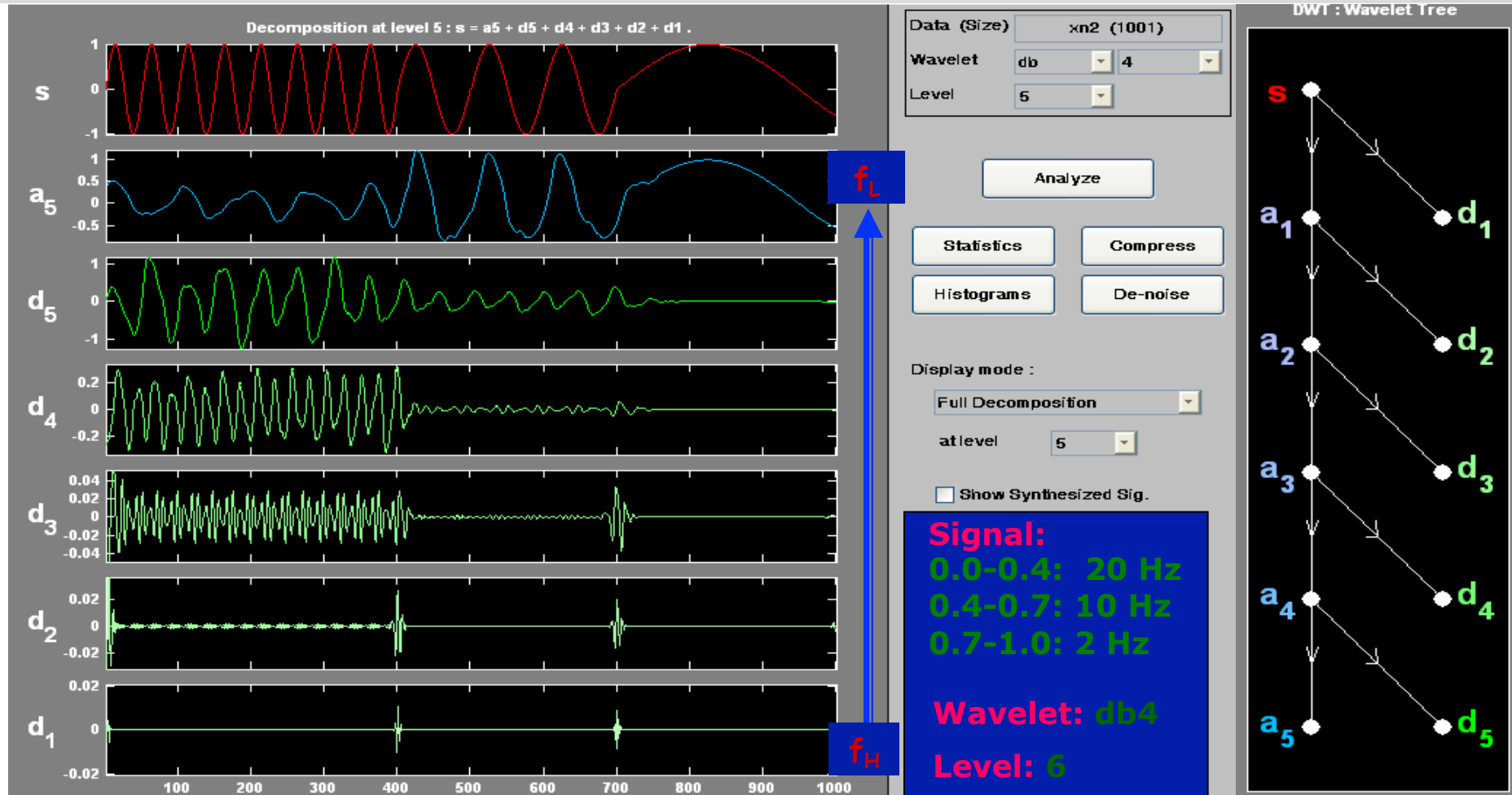

At 0<sup>th</sup> level frequency is assumed to be between 0-300Hz.

So the 1<sup>st</sup> decomposition splits the signal in  $a_1$ :0-160Hz and  $d_1$ :160-300Hz.

Analysis continues subdividing the low frequency component.

Image courtesy of Fengxiang Qiao, [http://cseweb.ucsd.edu/~baden/Doc/wavelets/qiao\\_wavelet\\_intro.pdf](http://cseweb.ucsd.edu/~baden/Doc/wavelets/qiao_wavelet_intro.pdf)



# DWT example

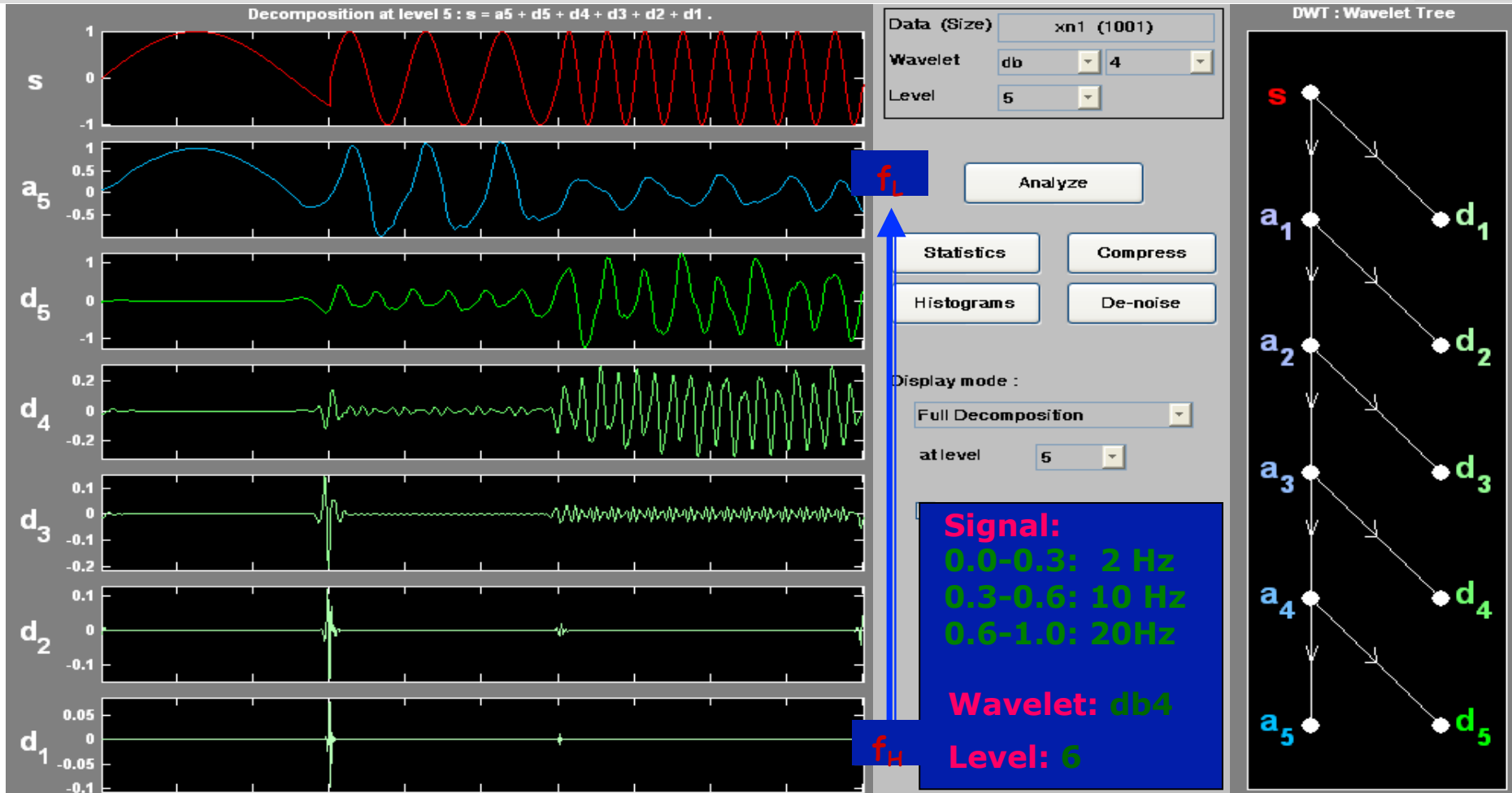

At 0<sup>th</sup> level frequency is assumed to be between 0-300Hz.

So the 1<sup>st</sup> decomposition splits the signal in a<sub>1</sub>:0-160Hz and d<sub>1</sub>:160-300Hz.

Analysis continues subdividing the low frequency component.

Image courtesy of Fengxiang Qiao, [http://cseweb.ucsd.edu/~baden/Doc/wavelets/qiao\\_wavelet\\_intro.pdf](http://cseweb.ucsd.edu/~baden/Doc/wavelets/qiao_wavelet_intro.pdf)



# The Math Behind the DWT

- Let  $g(t)$  be the half-band low-pass filter and  $h(t)$  be the half-band high-pass filter.
- Applying the low-pass filter means:

$$f(t) * g(t) = \sum_{k=-\infty}^{\infty} f(k)g(t-k)$$

- Downsampling by a factor of 2 after filtering is equivalent to:

$$y_{low}(t) = \sum_{k=-\infty}^{\infty} g(k)f(2t-k)$$

- Similarly

$$y_{high}(t) = \sum_{k=-\infty}^{\infty} h(k)f(2t-k)$$

$g(t)$ : low-pass filter  
 $h(t)$ : high-pass filter



## Another View of Wavelets

- A specific wavelet instantiation (a wavelet child)  $\psi_{\tau,\alpha}^*(t)$  oscillates at a specific frequency and for a specific duration.
- When I overlay a complex signal  $f(t)$  with  $\psi_{\tau,\alpha}^*(t)$  if the signal contains this particular oscillating frequency at a time instance  $t_k$ , then I would get a high response at location  $t_k$ .
- So when I convolve a signal with a specific wavelet I obtain all the locations where the particular wavelet is one of the component frequencies of the signal.



# Wavelet Decomposition

- In a similar manner to the Fourier Transform (or the projection to orthogonal basis methods), one can then define a set of complementary wavelets which can deconstruct a signal to its component frequencies.
- In other words, one can use wavelets as a set of orthogonal basis functions.
- When this set of wavelets is properly chosen, the original signal can be reconstructed from the projected data with minimal loss of information.
- Representing a signal using a set of wavelet basis functions is called a **Wavelet Series**.





# Wavelet Series

- When a set of discrete wavelets is used to transform a continuous signal the result is known as a wavelet series decomposition.
- Since the wavelet basis is assumed to be known one only needs to store the corresponding wavelet coefficients.
- A typical orthonormal wavelet basis set is of the following form:

$$\psi_{m,k}(t) = \sqrt{2^m} \psi(2^m t - k)$$

where  $\psi(t)$  is the Haar wavelet and  $m, k \in \mathbb{Z}$ .



# Wavelet Basis Functions

- More formally, a wavelet series representation of a square integrable function is its decomposition into an orthonormal basis set generated by a wavelet.
- A function  $\psi(t)$  is an orthonormal wavelet if it has the following form:

$$\psi_{m,k}(t) = \sqrt{2^m} \psi(2^m t - k)$$

where  $m, k \in \mathbb{Z}$

and

$$\langle \psi_{j,k}(t), \psi_{l,m}(t) \rangle = \int_{-\infty}^{\infty} \psi_{j,k}(t) \psi_{l,m}^*(t) dt = \delta_{j,l} \delta_{k,m}$$

where  $\delta_{j,l} = \begin{cases} 1 & \text{for } j = l \\ 0 & \text{otherwise} \end{cases}$



# Wavelet Series Decomposition

- One can then use this orthonormal wavelet basis set to represent a signal  $f(t)$ :

$$f(t) = \sum_{j=-\infty}^{\infty} \sum_{k=-\infty}^{\infty} c_{j,k} \psi_{j,k}(t)$$

- This representation of  $f(t)$  is known as the **wavelet series**.
- The wavelet coefficients  $c_{m,k}$  can be directly computed by:

$$c_{m,k} = \text{WT}(2^{-m}, k2^{-m})$$

where

$$\text{WT}(m,k) = \frac{1}{\sqrt{m}} \int_{-\infty}^{\infty} f(t) \psi^* \left( \frac{t-k}{m} \right) dt$$

# CWT, DWT and WS



- CWT has a lot of redundancy.
- For signal encoding and compression DWT is usually sufficient.
- For signal analysis (like Pattern Recognition) the exact CWT or WS coefficients are used because
  - they are more robust to noise
  - they are more informative



# 2D Wavelets

- When analyzing 2D signals,  $f(x,y)$ , one has to apply the wavelet in each direction, i.e.  $x$  and  $y$  separately, as well as on their combination.
- For example the 2D mother Haar wavelet looks like:

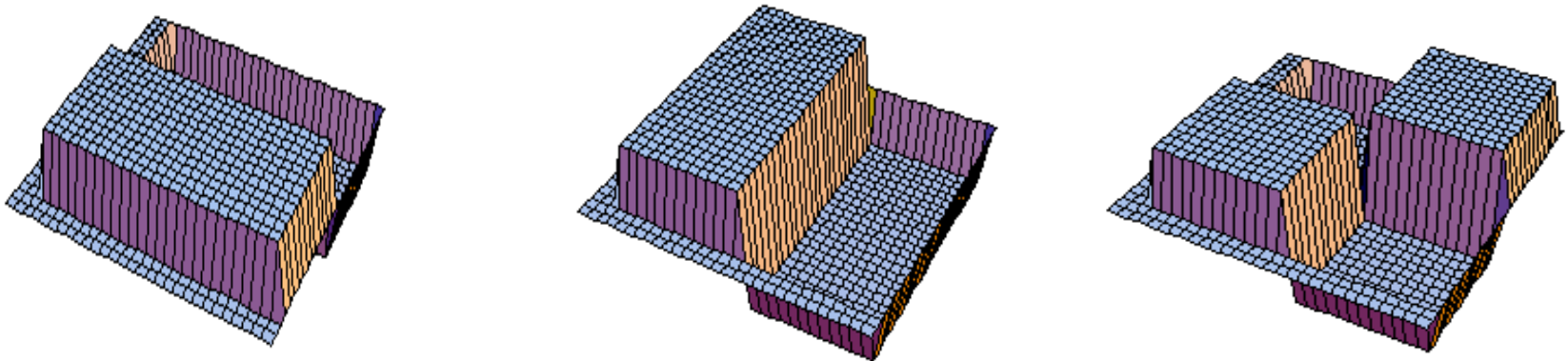



# 2D Wavelet Decomposition

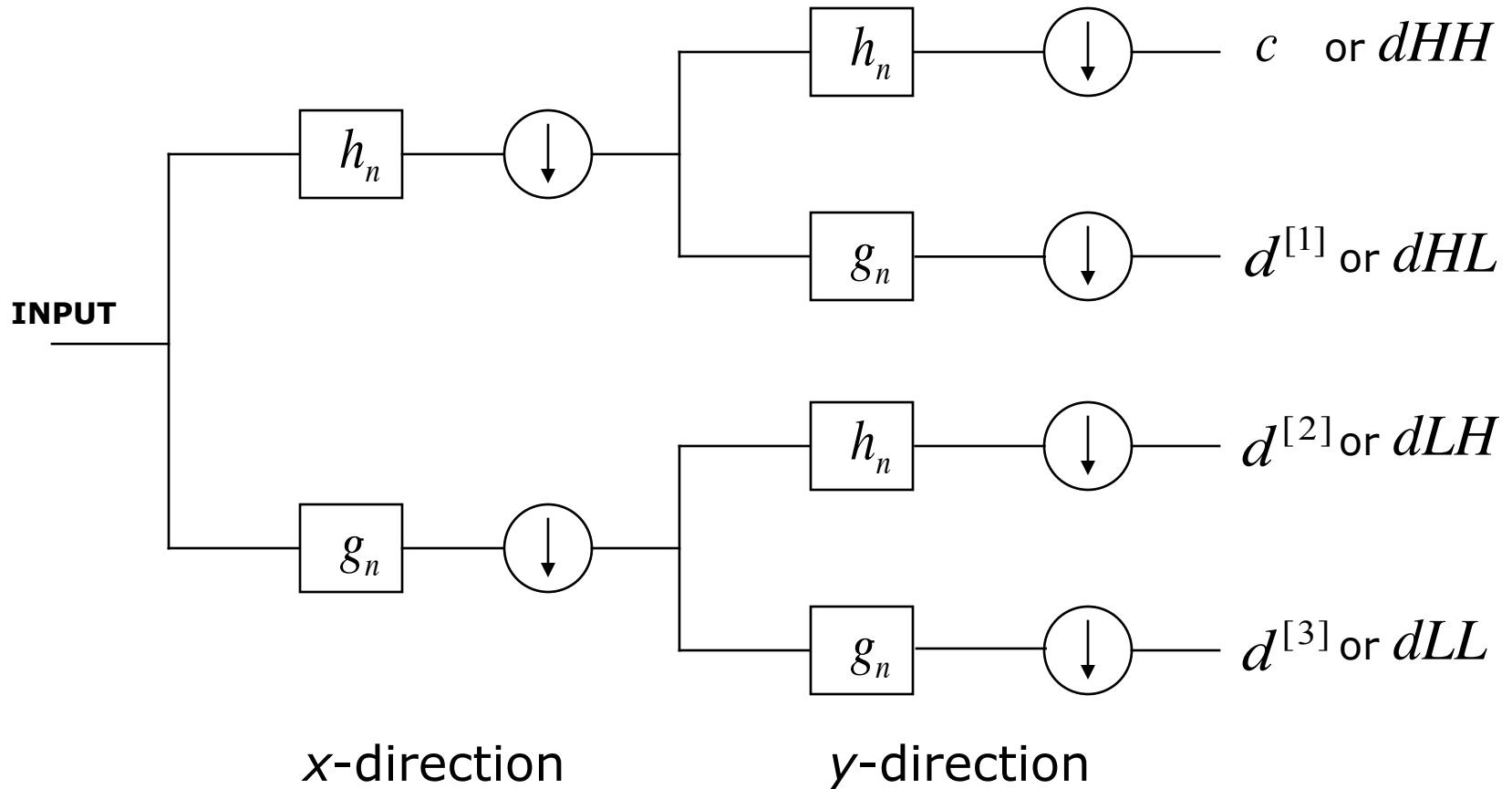

$g_n$ : low-pass filter  
 $h_n$ : high-pass filter

# Typical Wavelet Decomposition of an Image

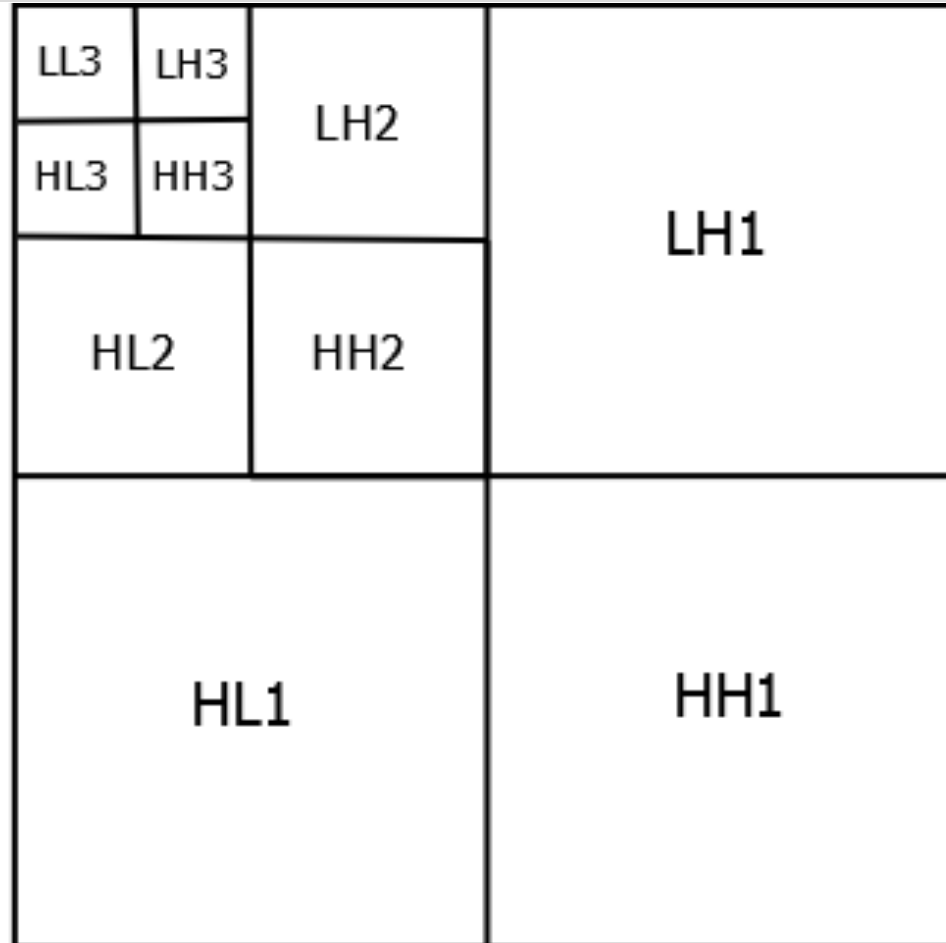

## Three Level Wavelet Image Decomposition

Image taken from <http://code.google.com/p/wavelet1d/wiki/Functions>

# DWT example

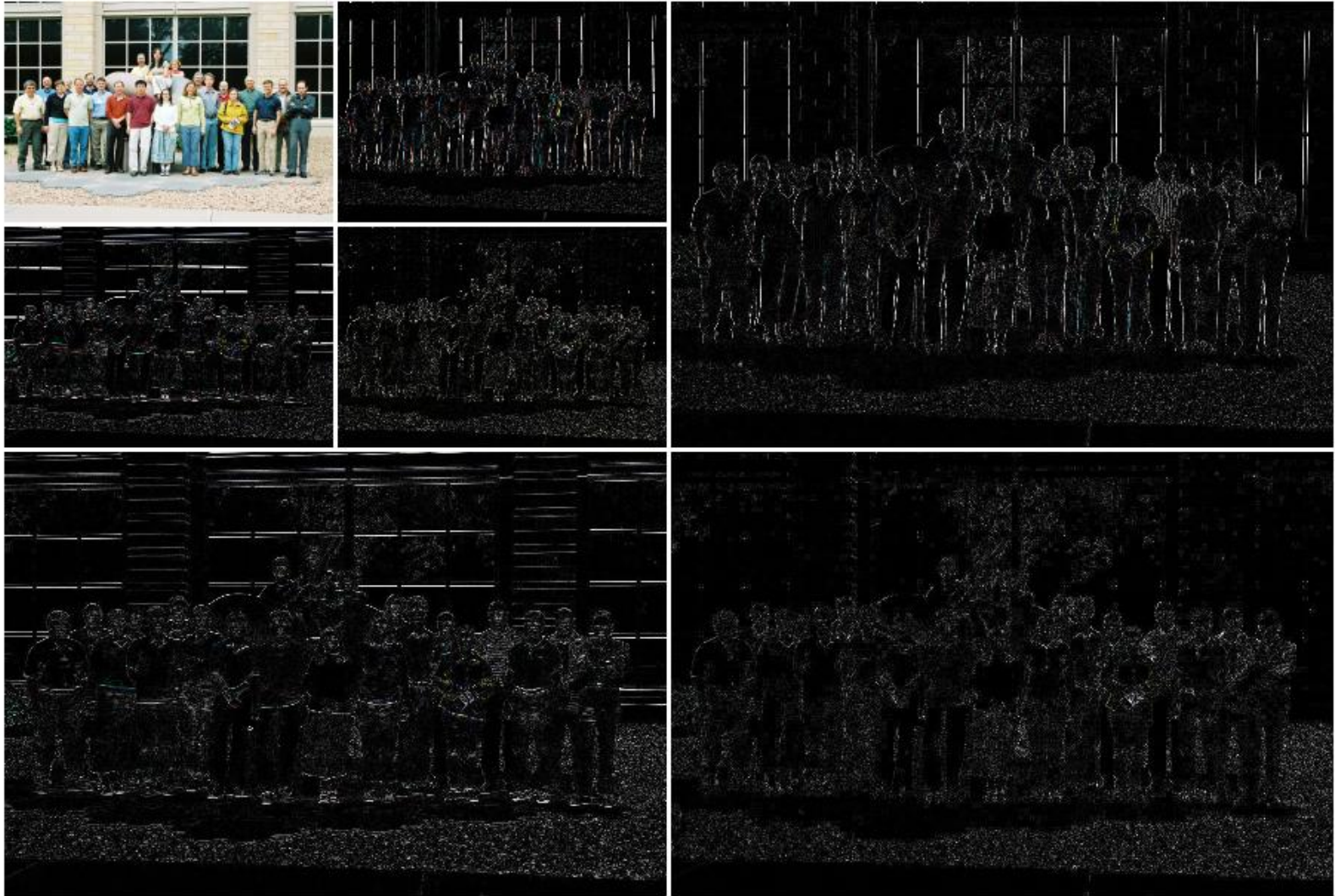

Image courtesy of <http://cam.mathlab.stthomas.edu/wavelets/waveletworkshopwt.jpg>



# DWT example

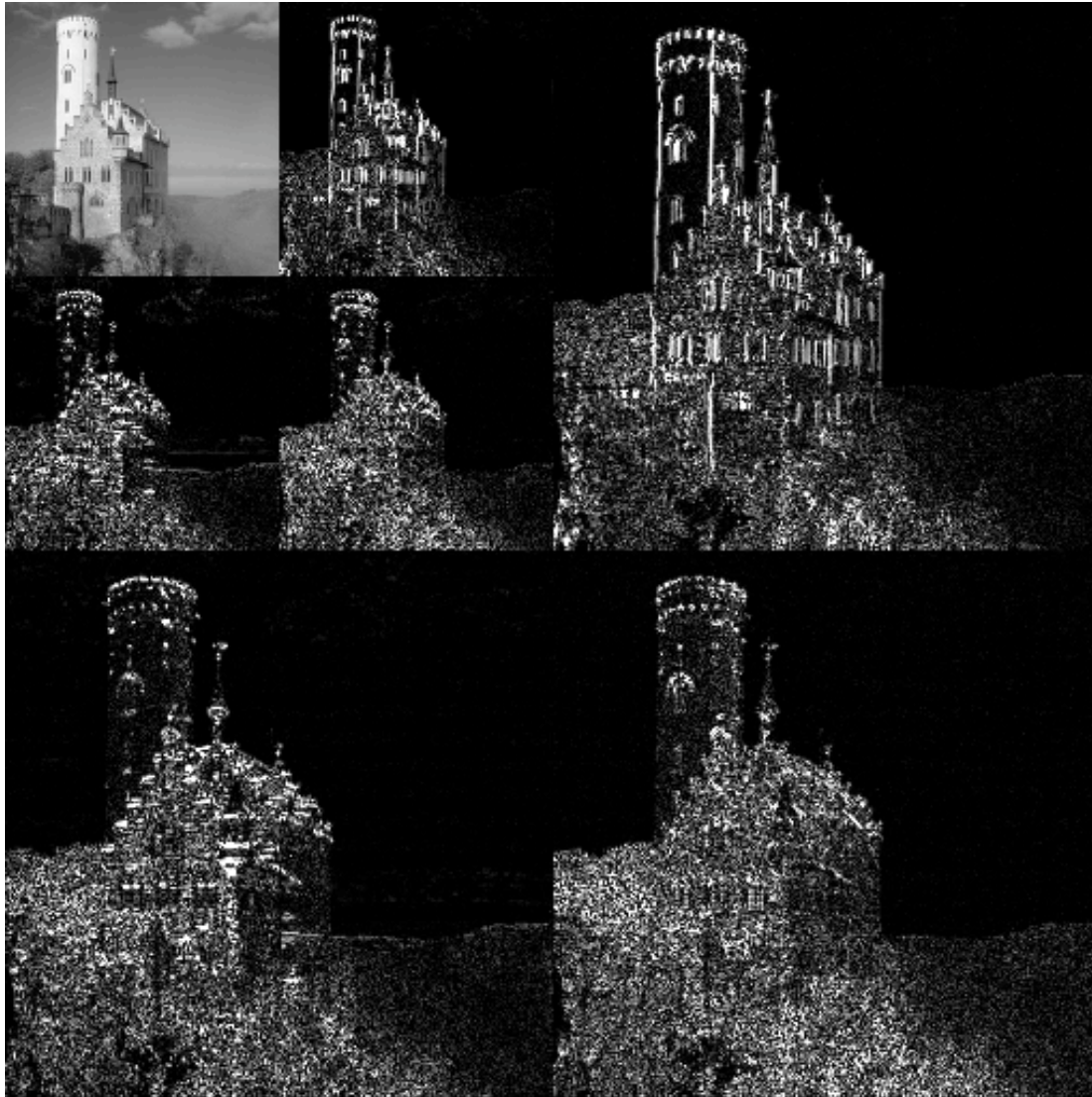
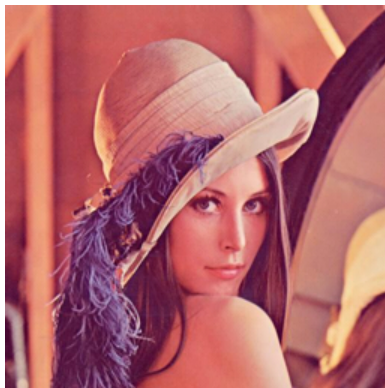

Image courtesy of <http://commons.wikipedia.org>



# Wavelet Based Image Compression

- The improved compression performance of JPEG 2000 over JPEG is attributed to:
  - the use of DWT
  - a more sophisticated entropy encoding scheme
- The difference between lossy and lossless image compression in JPEG 2000 is that lossless compression uses a reversible integer wavelet transform.



original

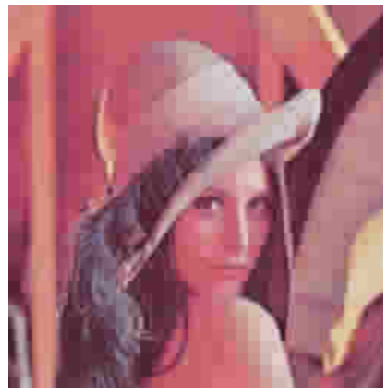

JPEG 43:1  
compression



JPEG 2000 43:1  
compression

# Wavelet-Based Video Compression



- Consecutive frames typically differ slightly from each other.
- Store and transmit only the differences between consecutive frames.
- Wavelets allow a more compact representation, since wavelet coefficients suffice for storage and transmission.
- Store/transmit the difference in the wavelet coef. between consecutive frames.
- Wavelets can “zoom in” on those areas of the image where the change has occurred.



# Example of Wavelet Decomposition

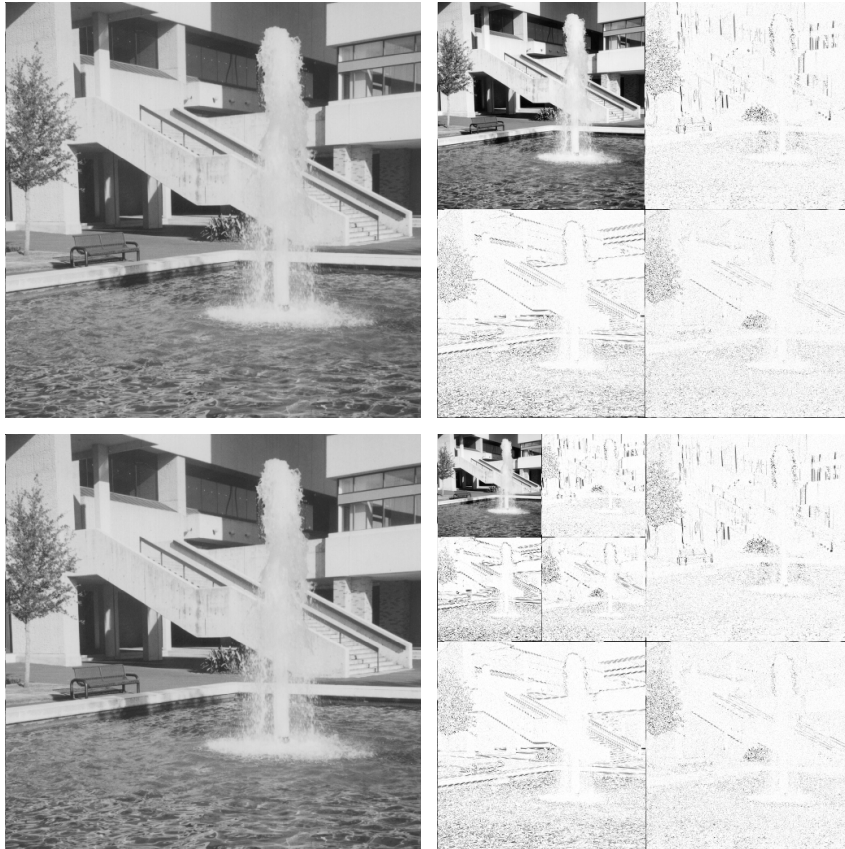

Wavelet decomposition and reconstruction of an image.

(a) Original image (top left).

(b) First level coefficients of decomposition (top right).

(c) Reconstructed image (bottom left).

(d) Second level coefficients of decomposition (bottom right).



# Example of Wavelet Decomposition – cont.

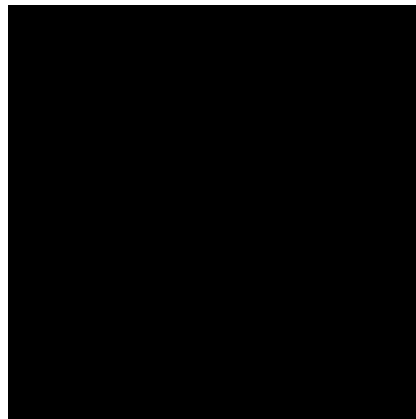
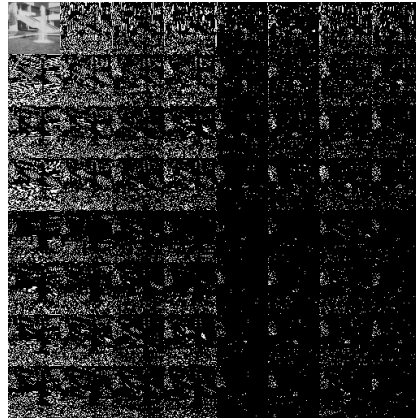

Wavelet decomposition and reconstruction of an image.

(a) Original image (top left).

(b) Third-level coefficients of decomposition (top right).

(c) Reconstructed image (bottom left).

(d) Error of reconstruction (bottom right).

# Different Types of Wavelets



Original image

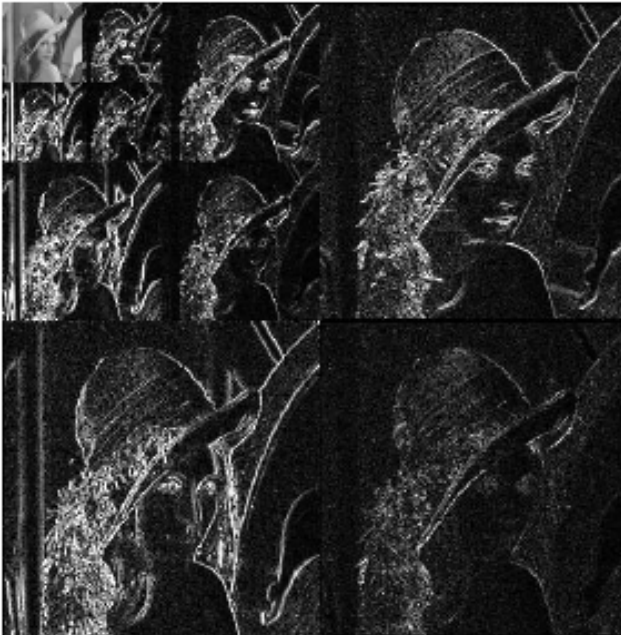

Haar wavelets

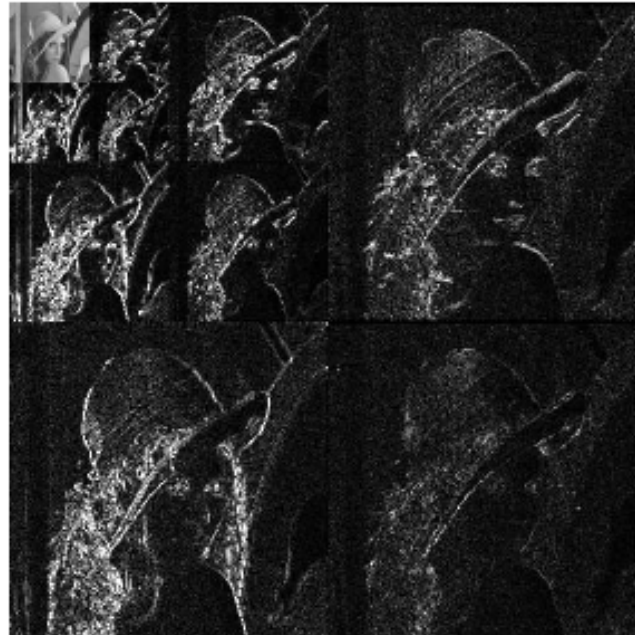

Daubechies wavelets

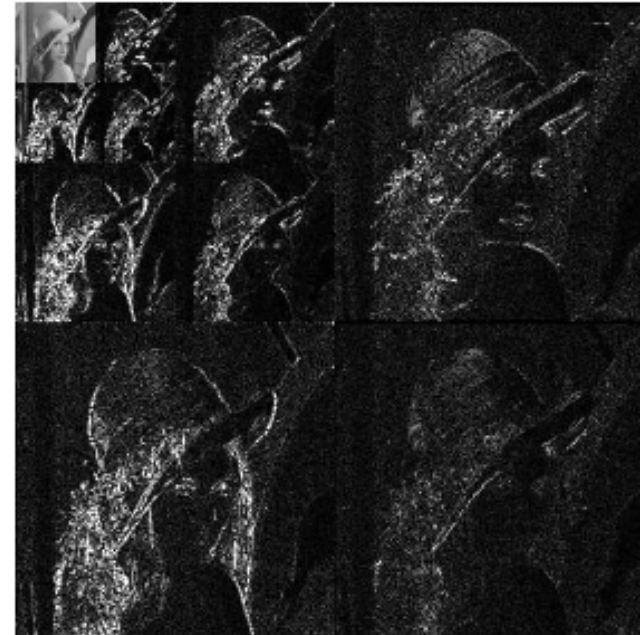

Biorthogonal wavelets



# DWT in texture classification

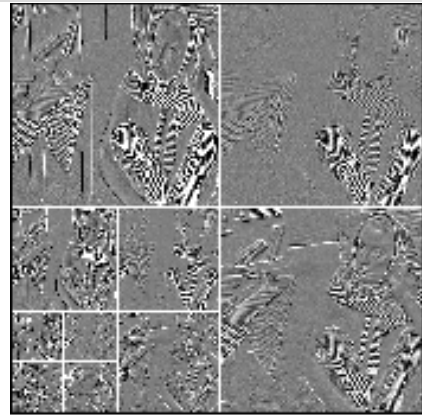

(a)



(b)

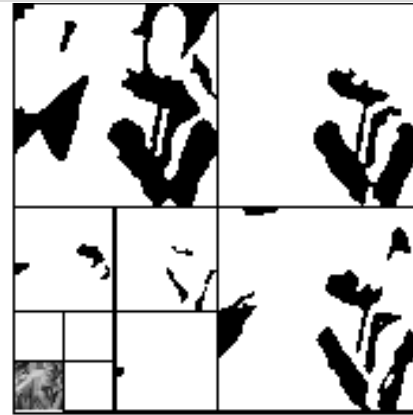

(c)

(a) wavelet image;  
 (b) energy distributions in the different frequency subbands, the darker the pixel the higher the energy;  
 (c) binarized energy image;  
 (d) color coded regions of distinct textures;  
 (e) texture regions overlaid in original image.



(d)



(e)



# People Classifier Based on Haar Wavelets

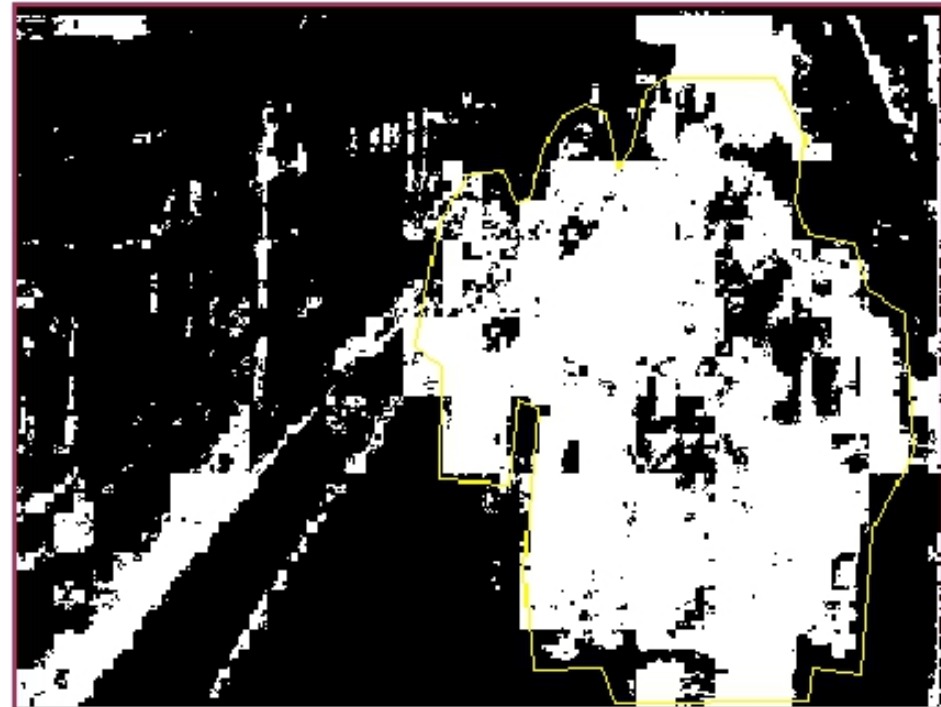

Two-class classifier: person vs. non-person

Feature vector: 21-dimensional coefficients of Haar wavelet; one feature vector per pixel.

Classifier: statistical classifier